

# **MPC-2240 Series Hardware Manual**

---

**Second Edition, March 2015**

[www.moxa.com/product](http://www.moxa.com/product)



© 2014 Moxa Inc. All rights reserved.

# MPC-2240 Series Hardware Manual

The software described in this manual is furnished under a license agreement and may be used only in accordance with the terms of that agreement.

## Copyright Notice

© 2014 Moxa Inc. All rights reserved.

## Trademarks

The MOXA logo is a registered trademark of Moxa Inc.  
All other trademarks or registered marks in this manual belong to their respective manufacturers.

## Disclaimer

Information in this document is subject to change without notice and does not represent a commitment on the part of Moxa.

Moxa provides this document as is, without warranty of any kind, either expressed or implied, including, but not limited to, its particular purpose. Moxa reserves the right to make improvements and/or changes to this manual, or to the products and/or the programs described in this manual, at any time.

Information provided in this manual is intended to be accurate and reliable. However, Moxa assumes no responsibility for its use, or for any infringements on the rights of third parties that may result from its use.

This product might include unintentional technical or typographical errors. Changes are periodically made to the information herein to correct such errors, and these changes are incorporated into new editions of the publication.

## Technical Support Contact Information

[www.moxa.com/support](http://www.moxa.com/support)

### **Moxa Americas**

Toll-free: 1-888-669-2872  
Tel: +1-714-528-6777  
Fax: +1-714-528-6778

### **Moxa Europe**

Tel: +49-89-3 70 03 99-0  
Fax: +49-89-3 70 03 99-99

### **Moxa China (Shanghai office)**

Toll-free: 800-820-5036  
Tel: +86-21-5258-9955  
Fax: +86-21-5258-5505

### **Moxa Asia-Pacific**

Tel: +886-2-8919-1230  
Fax: +886-2-8919-1231

# Table of Contents

<b>1. Introduction</b>	<b>1-1</b>
Overview	1-2
Package Checklist	1-2
MPC-2240 Product Features	1-2
MPC-2240 Series Hardware Specifications	1-3
Optional Features for the MPC-2240	1-5
Hardware Block Diagram	1-5
<b>2. Hardware Introduction</b>	<b>2-1</b>
Appearance	2-2
Front View	2-2
Bottom View	2-2
Dimensions	2-3
SavvyTouch Display Control Buttons	2-3
Real Time Clock	2-4
<b>3. Hardware Connection Description</b>	<b>3-1</b>
Installation and Handling Notes	3-2
Desktop Mounting	3-2
Wall Mounting	3-3
FDMI/VESA Mounts	3-4
Wiring Requirements	3-6
Grounding the MPC-2240 Series	3-6
Powering on/off an MPC-2240 Computer	3-7
SavvyTouch Display Controls	3-7
Connecting Data Transmission Cables	3-8
Connecting to the Network	3-8
Connecting Serial Devices	3-8
Connecting NMEA 0183 Devices	3-9
Connecting Speakers or Headphones	3-10
Connecting a PS/2 Keyboard and Mouse	3-10
Connecting to USB Devices	3-10
Installing SATA Hard Disks	3-11
<b>4. Adjusting Screen Properties</b>	<b>4-1</b>
Installing the VGA Driver	4-2
Adjusting Display Resolution	4-5
Installing the Touch Screen Driver	4-6
Performing Screen Calibration	4-11
<b>5. BIOS Setup</b>	<b>5-1</b>
Entering the BIOS Setup Utility	5-2
Main Information	5-3
Advanced Settings	5-3
Boot Configuration	5-4
Peripheral Configuration	5-4
HDC Configuration	5-5
Video Configuration	5-6
Chipset Configuration	5-8
Hardware Monitor	5-9
Security Settings	5-9
Set Supervisor Password	5-10
Power Settings	5-10
Boot Settings	5-11
Boot Type	5-11
PXE Boot to LAN	5-11
Add Boot Options	5-11
USB Boot	5-11
EFI Device First	5-11
Boot Delay Time	5-12
Legacy	5-12
Exit Settings	5-13
Exit Saving Changes	5-13
Save Change Without Exit	5-13
Exit Discarding Changes	5-13
Load Optimal Defaults	5-13
Load Custom Defaults	5-13
Save Custom Defaults	5-14
Discard Changes	5-14
Upgrading the BIOS	5-14

<b>6. Display Control Interface .....</b>	<b>6-1</b>
Connecting to the UART Control Interface .....	6-2
UART Command Format .....	6-3
Command Format Details .....	6-4
Downloading RGB Files.....	6-5
<b>A. Regulatory Approval Statement .....</b>	<b>A-1</b>
<b>B. UART Commands for Display Control.....</b>	<b>B-1</b>
UART Control Commands.....	B-2
BRI: Set the Minimum Brightness for the Display Panel.....	B-2
BRL: Set the LED Brightness for the Touch Keypad .....	B-2
BRM: Set the Maximum Brightness for the Display Panel.....	B-2
BRT: Set the Current Panel Brightness.....	B-2
BRU: Glass Display Control-Brightness Button.....	B-2
BZZ: Buzzer Control .....	B-3
DLN: Download ECDIS RGB Package.....	B-3
DL?: ECDIS RGB Package Query .....	B-3
ETC: Elapsed Time Counter Query .....	B-3
GMB: Glass Display Control - Minimum Brightness.....	B-4
POT: Potentiometer Control .....	B-4
SWI: Query the Scalar Board's Firmware Version .....	B-4
SWK: Touch Keypad Firmware Version Query .....	B-4
ADF: AC Input Power Detect Function .....	B-4
AD?: Query AC Input Power Detect Function Status.....	B-5
BLI: Brightness Control .....	B-5
DUF: Disable UART Command Function .....	B-5
EMS: ECDIS Mode Select.....	B-5

## Introduction

---

The MPC-2240 series of panel computers features advanced Intel processors—3rd generation Ivy Bridge Core or Celeron—matched with 4 GB of system memory, delivering a reliable, high-performance platform of wide versatility for use in industrial marine environments. With its RS-232/422/485 serial, NMEA 0183, and Gigabit Ethernet LAN ports, the MPC-2240 panel computer supports a wide variety of serial- and marine-specific interfaces alongside high speed IT communications, all with native network redundancy.

The MPC-2240 series comes with a range of standard display enhancements useful in industrial environments (including 0 to 100% full range dimming, 178°/178° wide viewing angles, optional optical bonding, and/or a multi-touch touch screen), as well as Moxa's innovative SavvyTouch display controls.

The MPC-2240 series of panel computers are compliant with key industrial marine standards, such as IEC 60945-4, IEC 61174, IEC 61162, DNV2.4, and IACS E10, verifying their resilient durability in marine operations. An optional IP65-rated unibody shell provides strong additional protection against the harsh conditions found in marine environments. The MPC-2240 delivers a rugged, type-approved, high performance and user friendly panel computer perfect for ECDIS navigation systems and other marine IBS applications.

The following topics are covered in this chapter:

- ❑ **Overview**
- ❑ **Package Checklist**
- ❑ **MPC-2240 Product Features**
- ❑ **MPC-2240 Series Hardware Specifications**
  - Optional Features for the MPC-2240
- ❑ **Hardware Block Diagram**

## Overview

The MPC-2240 Series panel computer range is a flexible all-in-one PC & monitor solution, designed for type approved use in industrial marine environments where reliability and durability are key requirements.

MPC-2240 panel computers feature Smart OSD Control, LED backlight technology, full dimming and multi-power all as standard. In addition there are options such as SSD storage device, multiple interface configurations and several OS options

## Package Checklist

MPC-2240 panel computers come with the following components and accessories:

**MPC-2240 Panel Computer:** Intel Celeron 1.4 GHz processor, tape bonded screen with AC/DC power input

Standard models ship with the following items:

- 1 MPC-2240 panel computer
- 2 keys for the locking, removable mass storage trays
- 1 terminal block for DC power input
- 4 5-pin Euroblock terminals for NMEA 0183 v2 interfaces
- Documentation and software DVD
- Quick installation guide (printed)
- Warranty card

Optional accessory packages are also available on request:

- Desktop mounting kit
- Wall mounting clamps
- VESA mounting kit

**NOTE** Please notify your sales representative if any of the above items are missing or damaged.

## MPC-2240 Product Features

- 24 inch full HD display screen
- Color calibration for ECDIS compliance available by request
- Fanless design
- SavvyTouch display controls
- 3rd Generation Intel® Core™ or Celeron® processor (Default: Celeron® 1047UE, 1.40 GHz with Intel® HD Graphics)
- Built-in NMEA 0183 and software selectable RS-232/422/485 interfaces (DI/DO and LPT available on request)
- Dual AC/DC power supply units
- Optically bonded and touch panel models available by request

# MPC-2240 Series Hardware Specifications

## Computer

**CPU:** Intel Celeron® Processor 1047UE (2M Cache, 1.40GHz), TDP 17 watts (standard model only, for other options, refer to MPC-2240 Available Option Table on P.1-5)

**OS:** N/A (For other options, refer to MPC-2240 Available Option Table on P.1-5)

**System Chipset:** Intel HM65

**System Memory:** 8 GB capacity, 4 GB pre-installed: 1 slot of 8 GB DDR3-1600 204 pin SO-DIMM SDRAM

**Storage:** 2 SATA III interfaces: 6 Gbps, 2.5" removable storage trays

**USB:** 4 bootable USB 2.0 hosts, type A connectors

**BIOS:** 64 Mbit Flash BIOS with SPI, ACPI

**Graphics Controller:** Intel HM65 Express chipset built-in

**Video Output:** 2 outputs: 1 DVI-D, 1 VGA (female)

## Other Peripherals

**Audio:** line in/out, 3.5 mm mini jack

**KB/MS:** 2 PS/2 interfaces supporting standard PS/2 keyboard and mouse

## Display

**Panel Size:** 24" viewable image size

**Aspect Ratio:** 16:9

**Pixels:** 1920 x 1080 (WSXGA+)

**Pixel Pitch (RGB):** 0.276 (H) x 0.276 (V) mm

**Response Time:** 25 ms (gray to gray)

**Contrast Ratio:** 5000:1

**Light Intensity:** 300 cd/m<sup>2</sup>

**Viewing Angles:** 178/178

**Active Display Area:** 531.36 (H) x 298.89 (V) mm

**Max Colors:** 16.7M (8 bit color)

**Resolution:**

- VGA: 640 x 480
- SVGA: 800 x 600
- XGA: 1024 x 768
- SXGA: 1280 x 1024
- WSXGA+: 1920 x 1080 (benchmarked setting)

**Panel Type:** MVA

**SavvyTouch Display Control Buttons:** ECDIS adjustment, INFO hardware reprot, Brightness (+, -), Power

## Ethernet Interface

**LAN:** 2 auto-sensing 10/100/1000 Mbps ports (RJ45)

**Magnetic Isolation Protection:** 1.5 kV built-in

## Serial Interface

**Serial Standards:** 2 RS-232/422/485 ports, software-selectable (DB9 male)

## Serial Communication Parameters

**Data Bits:** 5, 6, 7, 8

**Stop Bits:** 1, 1.5, 2

**Parity:** None, Even, Odd, Space, Mark

**Flow Control:** RTS/CTS, XON/XOFF, ADDC® (automatic data direction control) for RS-485

**Baudrate:** 50 bps to 921.6 Kbps (supports non-standard baudrates)

## Serial Signals

**RS-232:** TxD, RxD, DTR, DSR, RTS, CTS, DCD, GND

**RS-422:** TxD+, TxD-, RxD+, RxD-, GND

**RS-485-4w:** TxD+, TxD-, RxD+, RxD-, GND

**RS-485-2w:** Data+, Data-, GND

## NMEA Interface

**Serial Standards:** 8 NMEA 0183 ports

**Base Serial Standard:** RS-422

**Optical Isolation Protection:** ±6 kV contact discharge, ±8 kV air discharge

**Voltage Differential:** -15 V to + 15 V

**Baudrate:** 4800 bps

**Data Bits:** 8

**Stop Bits:** 1, 1.5, 2

**Parity:** None

**Handshake:** None

### LEDs

**LAN:** 100M/Link x 2, 1000M/Link x 2 (on connector)

### Physical Characteristics

**Housing:** Aluminum sheet metal

**Weight:** 12.4 kg

**Dimensions:** 595 x 393 x 75 mm (23.44 x 15.48 x 2.95 in)

**Mounting:** Flush mounting

### Environmental Limits

**Operating Temperature:** -15 to 55°C (5 to 131°F)

**Storage Temperature:** -20 to 60°C (-4 to 140°F)

**Ambient Relative Humidity:** 5 to 95% (non-condensing)

**IP Rating:** IP22

### Anti-Vibration:

- 0.7 g @ DNV2.4 (Class A), sine wave, 2-100 Hz, 1 Oct./min., 1.5 hr per axis
- 1 g @ DNV2.4, random wave, 3-100 Hz, 2.5 hr per axis
- 2.1 g @ DNV2.4 (Class C), sine wave, 2-50 Hz, 1 Oct./min., 1.5 hr per axis

### Power Requirements

#### Input Voltage:

- 24 VDC (18 to 36 VDC), screw-type terminal block
- 100 to 240 VAC, AC power inlet

**Power Consumption:** 40 to 75 W

### Standards and Certifications

**Safety:** UL/cUL, CCC

**EMC:** EN 55022 Class B, EN 55024-4-2, EN 55024-4-3, EN 55024-4-4, FCC Part 15 Subpart B Class A

**Marine:** IEC 60945 4th (pending), IEC 61174 (pending), IEC 61162 (pending), DNV2.4 (pending), IACS E10 (pending)

**Green Product:** RoHS, cRoHS, WEEE

### Reliability

**Automatic Reboot Trigger:** Built-in watchdog timer (WDT), configurable for resets following 1-255 second hang intervals

### Warranty

**Warranty Period:** 1 year

**Details:** See [www.moxa.com/warranty](http://www.moxa.com/warranty)



## Optional Features for the MPC-2240

<b>CPU</b>	Default	<ul style="list-style-type: none"> <li>Intel Celeron® processor 1047UE (2M Cache, 1.40GHz), TDP 17 watts</li> </ul>
	Options	<ul style="list-style-type: none"> <li>Intel Core™ i3 processor 3217UE (3M Cache, 1.60GHz), TDP 17 watts</li> <li>Intel Core™ i7 processor 3517UE (4M Cache, 2.80GHz), TDP 17 watts</li> </ul>
<b>RAM</b>	Default	4 GB
	Option	8 GB (max.)
<b>OS</b>	Default	N/A
	Options	<ul style="list-style-type: none"> <li>Windows 7 Professional</li> <li>Windows XP Embedded</li> <li>Windows Embedded Standard 7</li> <li>Windows XP SP3</li> <li>Linux Debian 7</li> </ul>
<b>Factory Options</b>	<ul style="list-style-type: none"> <li>Projected capacitive touch screen (multi-touch, USB interface)</li> <li>Optical bonding</li> <li>Color calibrated for ECDIS</li> <li>Customized options for SSD drives</li> </ul>	

## Hardware Block Diagram

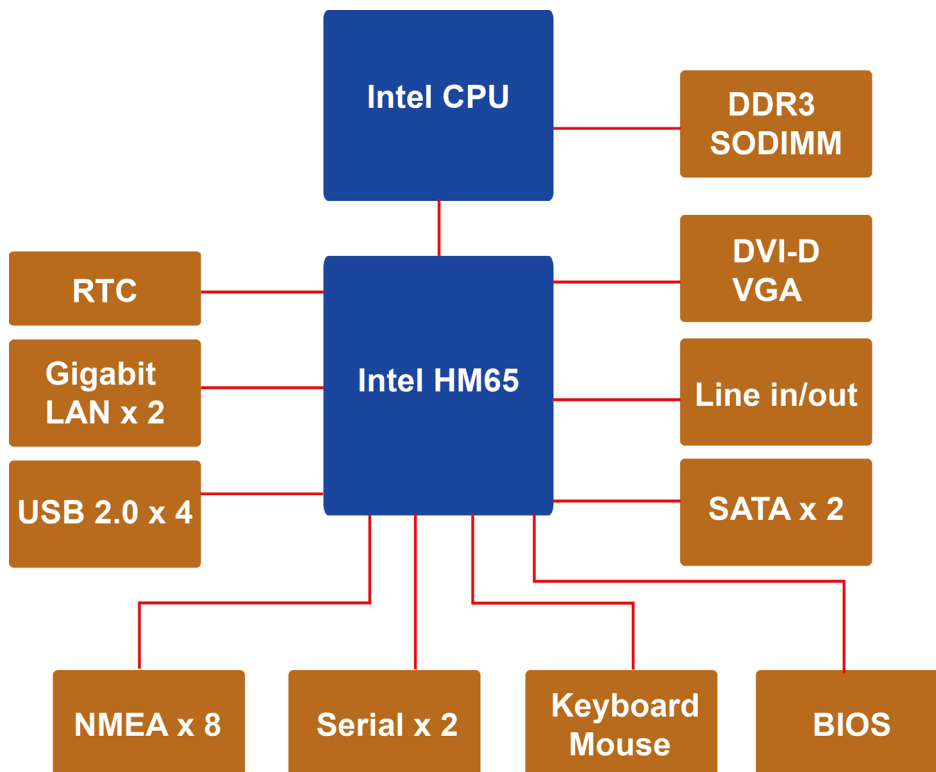

# Hardware Introduction

---

MPC-2240 computers are compact, well-designed, and hardened for industrial marine applications. Intelligent SavvyTouch display control buttons allow end users to easily locate and manipulate control buttons in low light environments, or to receive immediate system hardware reports to aid in troubleshooting system failures. and The MPC-2240 features a reliable and stable hardware platform with multiple serial ports, for connecting a wide variety of data devices.

The following topics are covered in this chapter:

- ❑ **Appearance**
  - Front View
  - Bottom View
- ❑ **Dimensions**
- ❑ **SavvyTouch Display Control Buttons**
- ❑ **Real Time Clock**

# Appearance

## Front View

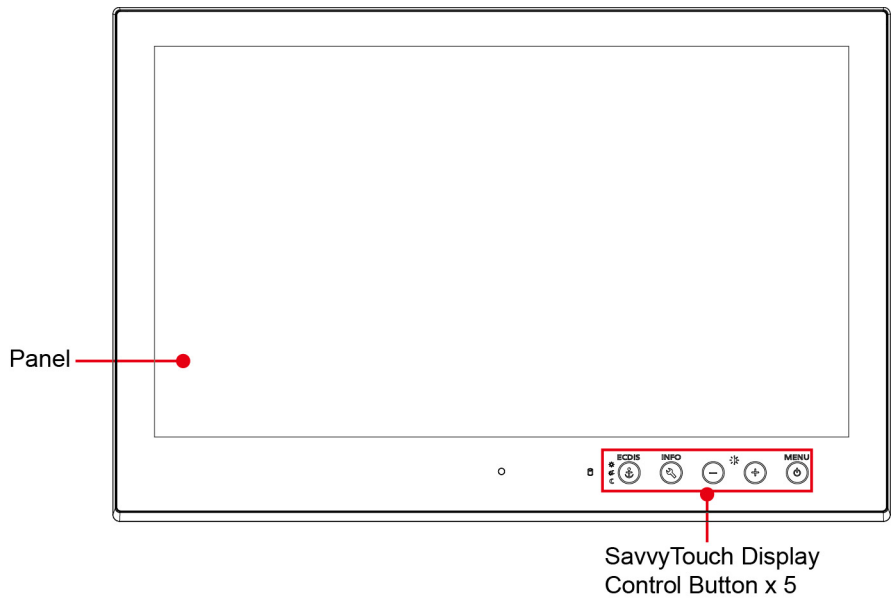

## Bottom View

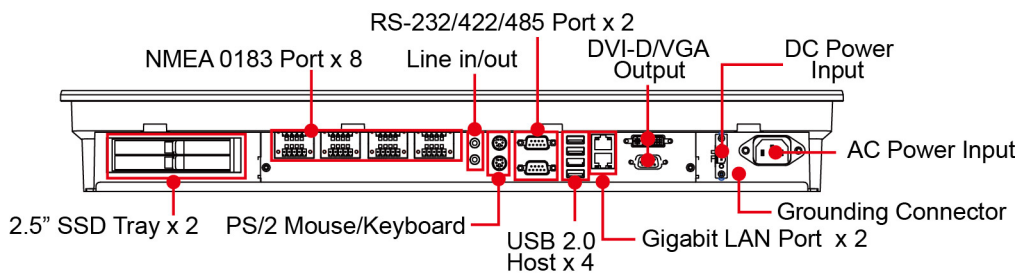



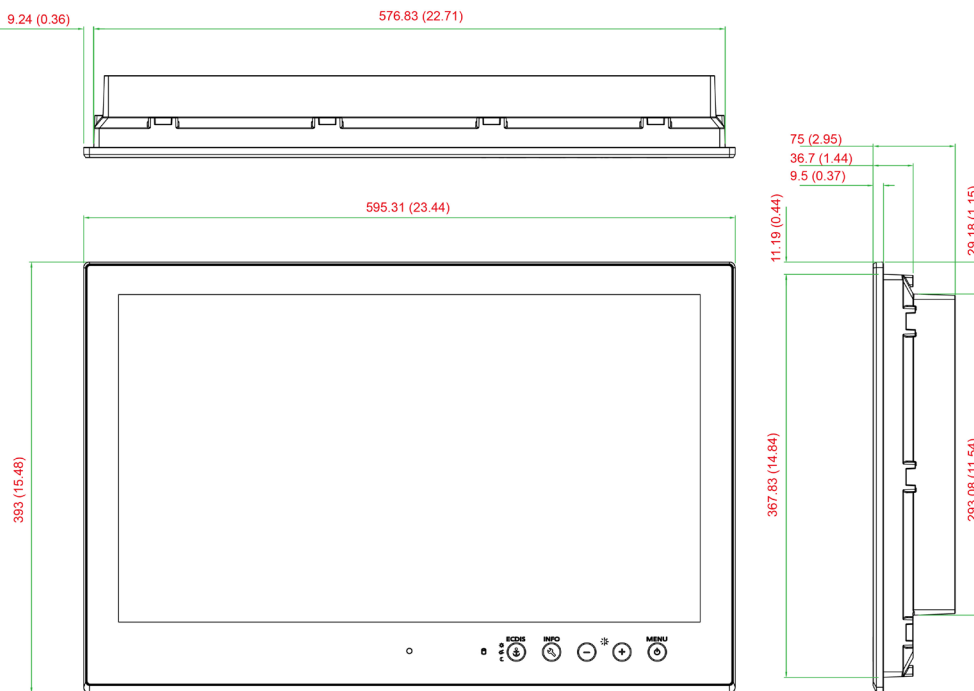

# Dimensions



## SavvyTouch Display Control Buttons

The MPC-2240 comes with SavvyTouch display controls situated in the lower right corner of the screen. These intelligent buttons will light up automatically when your fingers draw near. Refer to the following table for more information on each button.

Name	Displayed Color	Control Function / Color Legend
 Power	Green	Computer is powered on and functioning normally
	Red	Power standby and system shut down
	Off	Power is off.
 Brightness	White	+ : To increase brightness of panel - : To decrease brightness of panel
 Info	Off	System functioning normally
	Red	System hardware error
 Storage	Red (on)	Storage drive is functioning properly
	Red (blinking)	Drive is accessing or writing data
	Off	Drive is offline.
 Display mode (ECDIS models only)	White	Displays the brightness mode
	Off	Panel brightness out of ECDIS standard range

## Real Time Clock

The embedded computer's real-time clock is powered by a lithium battery. We strongly recommend that you **NOT** replace the lithium battery on your own. If the battery needs to be changed, please contact the Moxa RMA service team.



### **ATTENTION**

There is a risk of explosion if the wrong type of battery is used. To avoid this potential danger, always be sure to use the correct type of battery. Contact the Moxa RMA service team if you need to replace your battery.

# Hardware Connection Description

---

In this chapter, we show how to connect the embedded computers to the network and to various devices.

The following topics are covered in this chapter:

- ❑ **Installation and Handling Notes**
  - Desktop Mounting
  - Wall Mounting
  - FDMI/VESA Mounts
- ❑ **Wiring Requirements**
- ❑ **Grounding the MPC-2240 Series**
- ❑ **Powering on/off an MPC-2240 Computer**
  - SavvyTouch Display Controls
- ❑ **Connecting Data Transmission Cables**
  - Connecting to the Network
  - Connecting Serial Devices
  - Connecting NMEA 0183 Devices
- ❑ **Connecting Speakers or Headphones**
- ❑ **Connecting a PS/2 Keyboard and Mouse**
- ❑ **Connecting to USB Devices**
- ❑ **Installing SATA Hard Disks**

# Installation and Handling Notes

Before installing and mounting the MPC-2240 panel computer, please read the following notes:

1. The MPC-2240 series is designed for mounting on a **desktop, wall**, or an **FDMI/VESA interface**. Please refer to the relevant mechanical drawings in the next few sections for detailed instructions on each method.
2. To prolong product lifespan good ventilation must be maintained around the machinery. The chassis' heat-sink area **MUST** keep clear from other heat generating items, otherwise damage to the system motherboard may occur. The minimal distance that must be maintained between the heat sink and another heat source is 150 mm.
3. **DO NOT** install the unit horizontally (i.e.: lying down, on its back), as the heat will not be dissipated effectively and will damage the LCD panel. To assure adequate heat dissipation the unit should be installed vertically, or within a  $\pm 40$  degrees slope off the vertical..
4. Exposure to extreme direct sunlight may cause a considerable increase in the temperature of the unit, and under certain circumstances might lead to overheating. Please take this point into consideration when the bridge equipment is being planned (sun shades, distance from the windows, ventilation, etc.)
5. Exposure to strong vibration or loud, chronic noise might affect functionality and/or product lifetime. It is advised to take vibration and noise into consideration during system assembly and installation, so that the mount point may be carefully selected to avoid exposure to undue vibration.
6. For maximum safety, at least two persons should work together to lift, place, and fasten the computer at its mount point. Before you lift or move the computer, first verify both it is turned off and no power is being supplied to the system. In addition, make sure you have prepared the correct screws for the mounting.

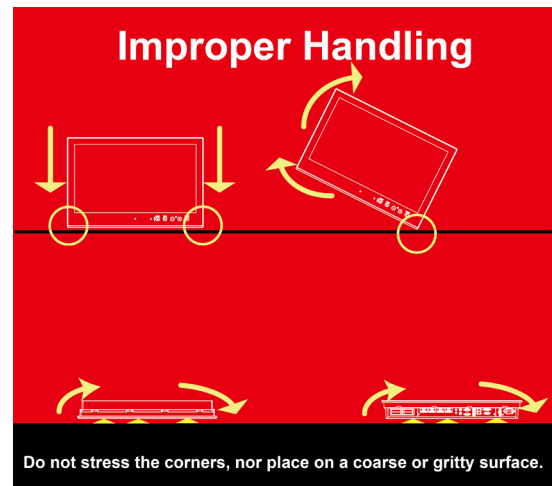
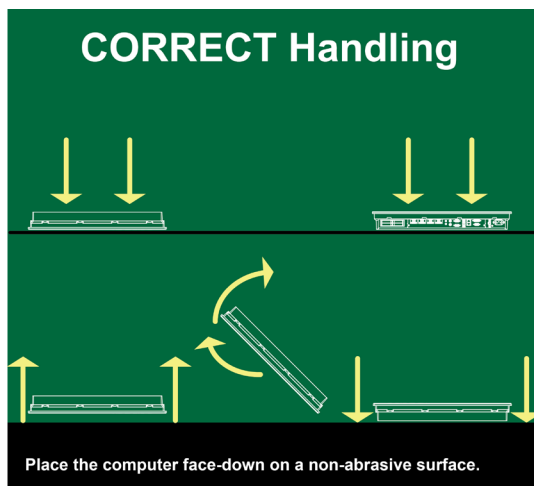

## Desktop Mounting

The MPC-2240 comes with optional brackets that allow you to install the panel computer on a horizontal surface such as a desktop. Please keep in mind that desktop mounting is only offered as a temporary mount; permanent use of the MPC-2240 as a desktop computer is not recommended.

Three round head screws are required for each bracket. See the figure at right for screw specifications and their torque value.

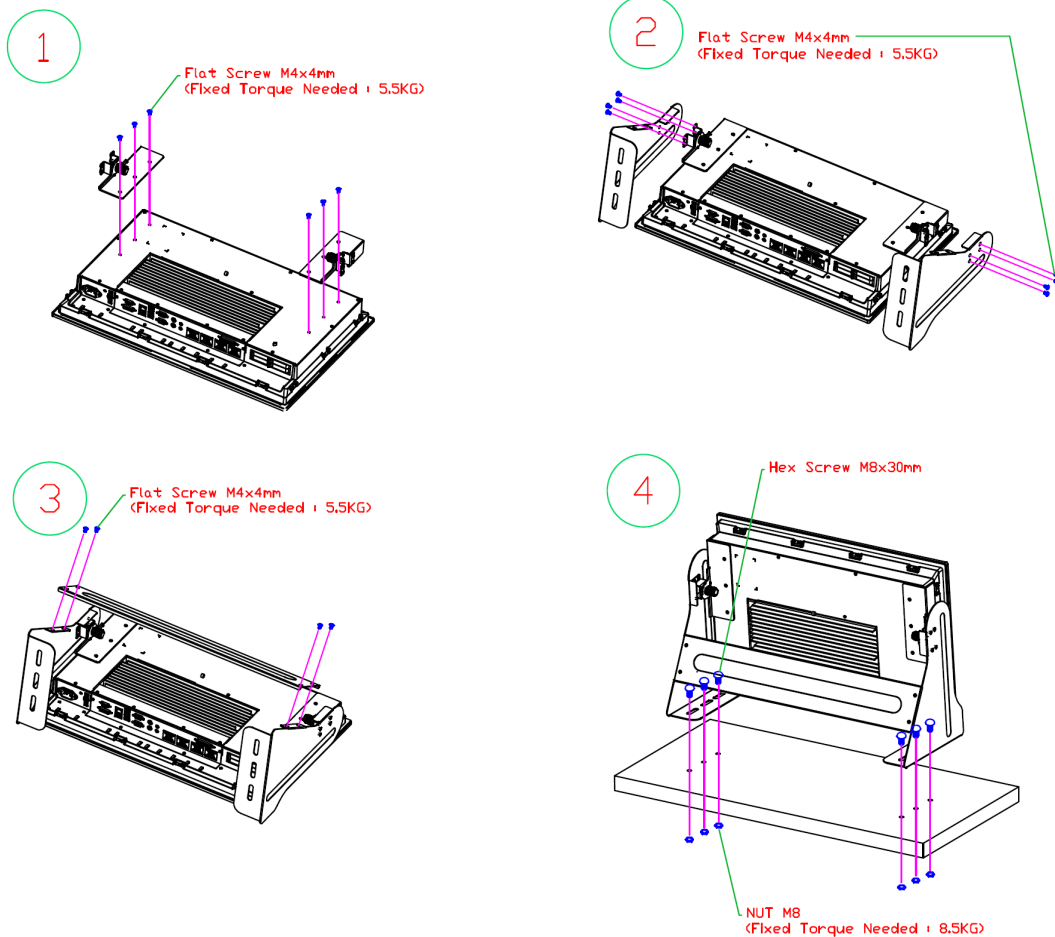

Place your MPC-2240 series panel computer on a clean, flat, well-ventilated desktop. For better ventilation, leave some space between the MPC-2240 and other equipment. Do not place equipment or objects on top of the computer, as this might damage the computer's internal components.

## Wall Mounting

The MPC-2240 Series comes with 14 optional clamp mounts that allow for installation onto a wall (where space has been cut out to accommodate the rest of the hardware) or into computing stations where a flush mount is desired. **The maximum thickness of the surface to which the computer may be clamped is 11 mm.** For a secure mounting, all 14 clamps must be used. The clamp arms are fastened into slots on all four sides of the MPC-2240. Use the short M4 SUS (stainless) screws to fasten the clamp arms to the MPC-2240 mounting slots, as shown in the magnified inset in the diagram just below. Next, use the clamps to fasten the computer to its mounting point; please note the torque value that is shown in the figure inset below.



Recommended Wall Cutout Dimension

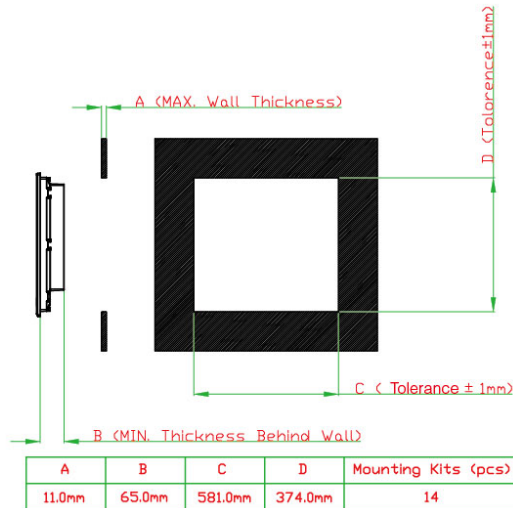

Panel Mount Kit

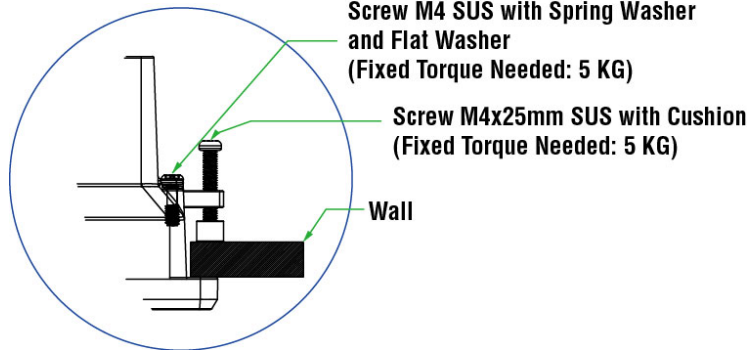
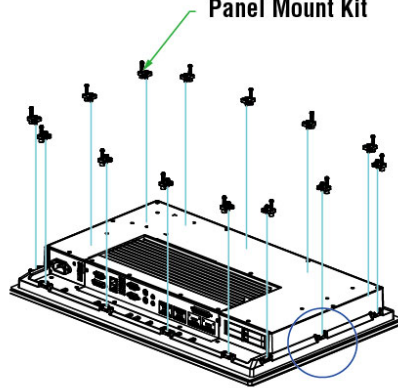

FDMI/VESA Mounts

The MPC-2240 series also comes with an optional VESA mount assembly. Six flat head screws and four round head screws are required to fasten the VESA mounting bracket. See the figure below for detailed screw specifications and torque values.

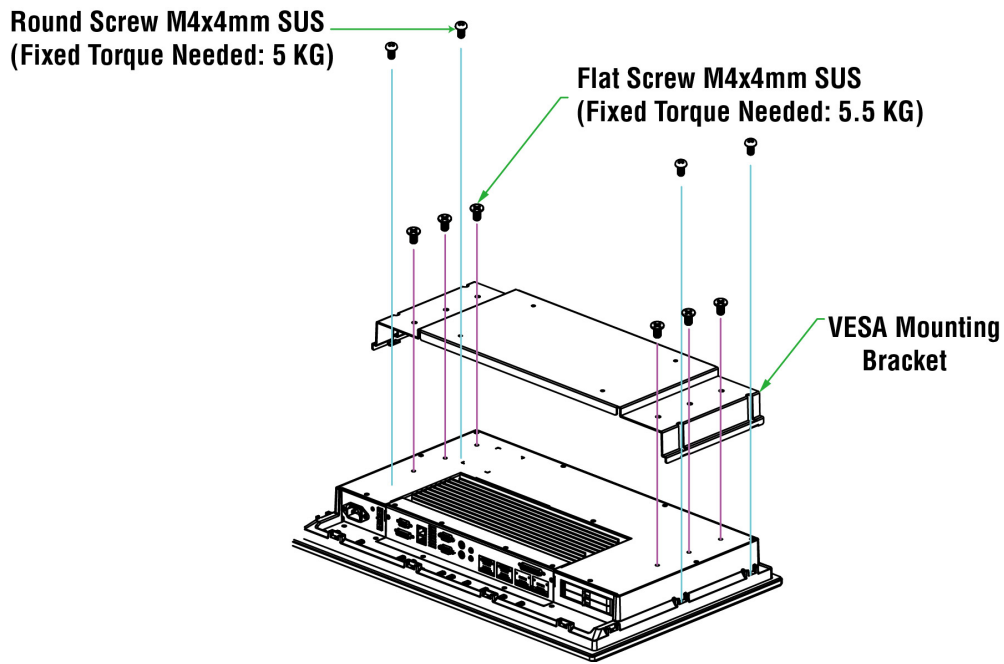

An additional four screws (not included in the kit) are required to mount the computer on a VESA rack. For this purpose, use M6 screws with a length between 10 and 12 mm.

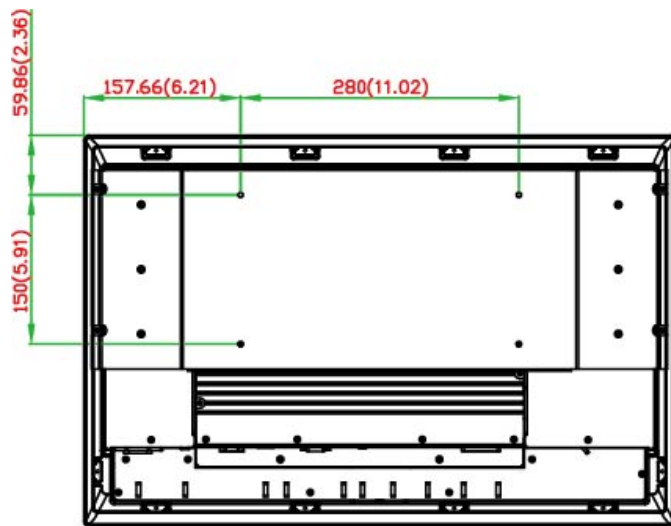

**VESA Mounting Kit**  
**4 M6 10 to 12 mm deep mounting holes**

# Wiring Requirements

This section describes how to connect serial devices to the embedded computer.

You should read and follow these common safety precautions before proceeding with the installation of any electronic device:

- Use separate paths to route wiring for power and devices. If power wiring and device wiring paths must cross, make sure the wires are perpendicular at the intersection point.

**NOTE** Do not run signal or communications wires together with power wires in the same conduit. To avoid interference, wires with different signal characteristics should be routed separately.

- Use the type of signal transmitted through a wire to determine which wires should be kept separate and which bundled together. The rule of thumb is that wiring that shares similar electrical characteristics can be bundled together.
- Keep input wiring and output wiring separate.
- It is advisable to label all wires used in the system.



**ATTENTION**

**Safety First!**

Be sure to disconnect the power cord before installing and/or wiring your MPC-2240 computer.

**Wiring Caution!**

Calculate the maximum possible current in each power wire and common wire. Observe all electrical codes dictating the maximum current allowable for each wire size.

If the current goes above the maximum ratings, the wiring could overheat, causing serious damage to your equipment.

**Temperature Caution!**

Be careful when handling the unit. When the unit is plugged in, the internal components generate heat, and consequently the outer casing may feel hot to the touch.

We recommend taking the following precautions to minimize heat build-up within the display:

- Position the display within  $\pm 40^\circ$  of the vertical.
- Install an external fan to increase airflow upwards through the display if (a) the display is not positioned within  $\pm 40^\circ$  of the vertical, (b) the ambient temperature exceeds 25°C, or (c) the display is used in a location with minimal ventilation.

**Important Safety Precaution**

Even though the display is rated to operate within the IEC 60945 standard of -15 to 55°C for marine applications, it is best to ensure that the ambient temperature does not exceed 25°C. Doing so will increase the life of your display and minimize service costs.

# Grounding the MPC-2240 Series

Before you power on the MPC-2240 Series, first ground it. Proper grounding and wire routing help limit the effects of noise due to electromagnetic interference (EMI). Run the ground connection from the ground screw to the grounding surface prior to connecting the power.

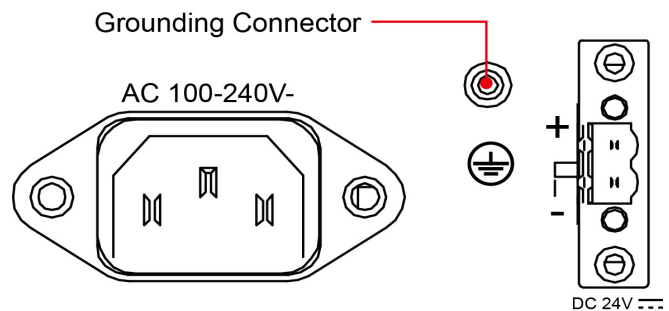

**ATTENTION**

This product is intended to be mounted to a well-grounded mounting surface, such as a metal panel.

# Powering on/off an MPC-2240 Computer

DC power is provided to the MPC-2240 via the Euroblock terminal located on the bottom panel of the case; a plug for the terminal is provided as part of the MPC-2240 package. Alternately, you may power the device using an AC power source by using the power cord provided.

Turn on the computer by touching and holding the **MENU** button (in the lower right corner of the display panel) for 1 second. It takes about 10 to 30 seconds for the system to boot up.

To power off the MPC-2240 Series, touch and hold the **MENU** button for 4 seconds; depending on your OS's power management settings you may enter **standby**, **hibernation**, or **system shutdown** mode (the available choices may be configured using your operating system's power management settings). If you encounter technical problems, touch the **MENU** button for 10 seconds to force a hard shutdown of the system.

## SavvyTouch Display Controls

The MPC-2240 Series comes with five SavvyTouch display controls located in the lower right corner of the screen. These intelligent controls will light up whenever a hand or other object draws near.

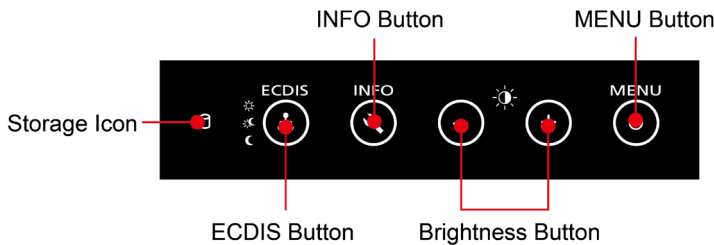

## MENU/Power Control

On the MPC-2240, the **MENU** button serves as the power button. To start or stop the computer, press and hold the button for 1 second. Once the system is powered up, the MENU button will light up in green. To power off the MPC-2240 Series, press and hold the MENU button for 4 seconds, and then choose to enter **standby**, **hibernation**, or **system shutdown** mode (the available choices may be configured using your operating system's power management settings). If you encounter technical problems, press and hold the MENU button for 10 seconds to force a hard shutdown.

## Brightness

Two brightness buttons are available for brightness control. The plus (+) button increases the brightness of the panel, and the minus (-) button decreases the screen brightness.

## INFO

The **INFO** button returns a status report (shown at right) of the AC power supply, main board, CPU, memory, the motherboard chipset, and VGA subsystems and components. When the panel computer is working as intended, **Pass** will be indicated (shown at right) for each subsystem/component. An error message will be shown when the system is not working. CPU, memory, chipset and VGA components are detected only in the boot stage. AC and motherboard Power are continuously monitored beginning with the system boot phase.

System Status	
AC Input Power	Pass
M / B Power	Pass
CPU	Pass
Memory	Pass
Chipset	Pass
VGA	Pass

## ECDIS Mode Brightness Adjustment

This button lets users switch among ECDIS-stipulated DAY, DUSK, and NIGHT modes; it is only available for ECDIS type approved models. On standard models, the button and all ECDIS-related controls are disabled.

Please note that use of this feature will reset the current brightness settings, and will take precedence over any other display settings.



## Storage



A storage indicator is located next to the controls. When data is being accessed the icon will blink red.

**NOTE** The MPC-2240 can also be controlled using commands over the UART interface; refer to **Appendix B: UART Commands for Display Control** for a detailed list of the available commands, and how to use them.

# Connecting Data Transmission Cables

This section describes how to connect the MPC-2240 panel computer to serial devices and the network.

## Connecting to the Network

Plug your network cable into the MPC-2240 Series' Ethernet port. The other end of the cable should be plugged into your Ethernet network. When the cable is properly connected, the LEDs on the embedded computer's Ethernet port will glow to indicate a valid connection. See the following figure for the location of the Ethernet ports.

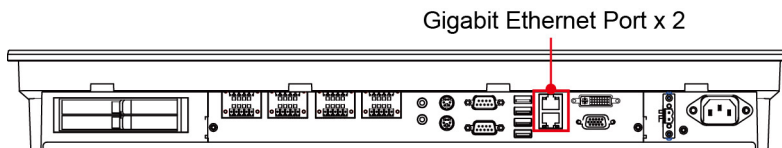

The 10/100/1000 Mbps Ethernet LAN port uses 8-pin RJ45 connectors. The following diagram shows the pinouts and the descriptions for these ports.

LED	Description
Green	100 Mbps Ethernet mode
Yellow	1000 Mbps (Gigabit) Ethernet mode
Off	No activity or 10 Mbps Ethernet mode

Pin	100 Mbps	1000 Mbps
1	ETx+	TRD(0)+
2	ETx-	TRD(0)-
3	ERx+	TRD(1)+
4	-	TRD(2)+
5	-	TRD(2)-
6	ERx-	TRD(1)-
7	-	TRD(3)+
8	-	TRD(3)-

## Connecting Serial Devices

Serial ports 1 and 2 have male DB9 connectors and can be configured for RS-232, RS-422, or RS-485 communications. See the figure below for the location of the serial ports.

Serial Port x 2  
(RS-232/422/485)

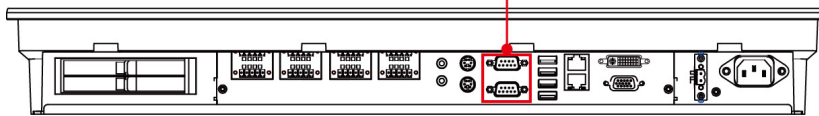

The pin assignments are shown in the following table:

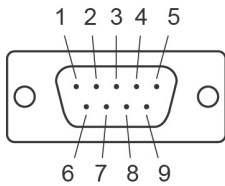

Pin	RS-232	RS-422	RS-485 (4-wire)	RS-485 (2-wire)
1	DCD	TxDA(-)	TxDA(-)	-
2	RxD	TxDB(+)	TxDB(+)	-
3	TxD	RxDB(+)	RxDB(+)	DataB(+)
4	DTR	RxDA(-)	RxDA(-)	DataA(-)
5	GND	GND	GND	GND
6	DSR	-	-	-
7	RTS	-	-	-
8	CTS	-	-	-

### Configuring RS-232/422/485 Serial Ports

For instructions on how to set the serial port for RS-232/422/485 communications, refer to the examples provided on the software CD.

For Windows 32-bit platforms, the examples may be found at:

**<Software DVD>\example\MPC-2240\Release\UartMode**

For Windows 64-bit platforms, the examples may be found at:

**<Software DVD>\example\MPC-2240\x64\Release\UartMode**

### Connecting NMEA 0183 Devices

The MPC-2240 Series comes with eight NMEA 0183 ports on the bottom panel. Refer to the following figure for the port location.

NMEA 0183 Port x 8

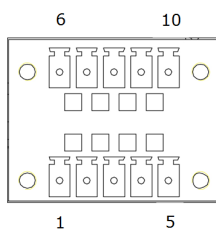
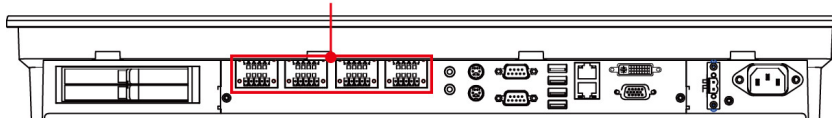

Pin	Pin assignment
1	TxD-, Transmit Data Negative
2	TxD+, Transmit Data Positive
3	GND, Ground
4	RxD-, Receive Data Negative
5	RxD+, Receive Data Positive
6	TxD-, Transmit Data Negative
7	TxD+, Transmit Data Positive
8	GND, Ground
9	RxD-, Receive Data Negative
10	RxD+, Receive Data Positive

**NOTE** You must use a 5-pin terminal block (3.81 mm) to connect to an NMEA port. The following figure shows a 5-pin terminal block (3.81 mm).

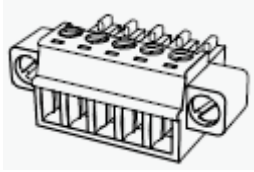

The accessory package that comes with the MPC-2240 includes eight 5-pin terminal blocks. To order additional 5-pin terminal blocks (P/N 111210511013), please contact your local Moxa sales representative.

## Connecting Speakers or Headphones

The MPC-2240 panel computer comes with standard 3.5 mm monaural line-in and line-out ports for connecting microphone, speakers, and headphones. See the following figure for detailed location.

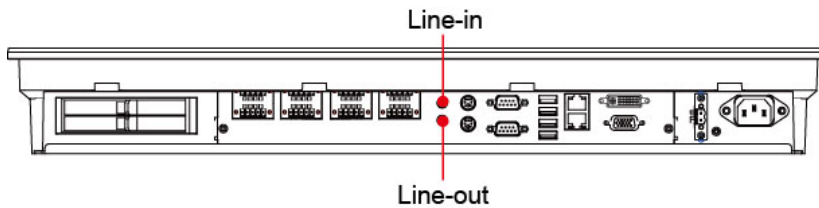

## Connecting a PS/2 Keyboard and Mouse

Your MCP-2240-MP computer comes with two PS/2 connectors to connect to a PS/2 keyboard (upper connector) and PS/2 mouse (lower connector). See the following figure for the detailed location.

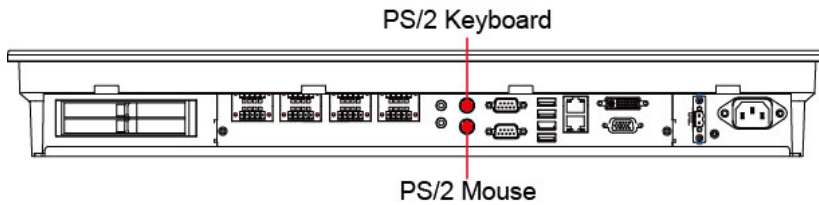

## Connecting to USB Devices

The MPC-2240 Series comes with 4 USB 2.0 ports on the bottom face of the computer. The ports may be used, among other things, for an external flash disk or hard drive for storing large amounts of data. You can also use these USB ports to connect to a keyboard or a mouse.

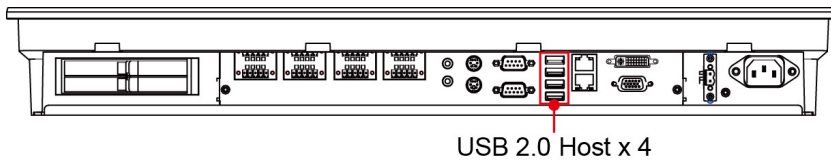

# Installing SATA Hard Disks

The MPC-2240 Series has two trays for SATA hard disks. To install the 2.5-inch SATA hard disks, follow these instructions. For the best reliability, we suggest you use solid state drives.

1. First, locate the SATA trays on the bottom surface of the computer. For ease of installation, we strongly suggest you lay the MPC-2240 on a non-abrasive surface with its display panel face down.
2. Insert the drive door key and turn it left to unlock the cover of the storage trays.
3. Open the tray cover by lifting the lever on the tray door.
4. Install the SATA drive into the tray. Make sure you insert it in the correct direction. Close the tray by pushing the door lever inwards. If you cannot smoothly secure the hard drive in the slot, it is most likely that you have inserted the drive in the wrong direction.
5. Make sure you have securely fastened the door lever. Use the same method to install another SATA hard disk into the other tray. If you need to install only one hard drive, we strongly suggest you install it in the tray nearest the display panel. If you need to install two hard drives, install the first disk in the tray nearest the display panel first, and then install the second disk in the other tray. When finished, use the protection key to lock the storage trays in place.
6. To remove a drive, simply pull up the door lever and fold the tray door back. The drive should automatically eject part way.

## Protection Lock





# Adjusting Screen Properties

---

This chapter describes how to install the VGA driver and the touch driver for touch screen models. After installing the drivers, you may use the software tools to adjust display resolution and touch screen features of the MPC-2240.

The following topics are covered in this chapter:

- ❑ **Installing the VGA Driver**
- ❑ **Adjusting Display Resolution**
- ❑ **Installing the Touch Screen Driver**
- ❑ **Performing Screen Calibration**

# Installing the VGA Driver

The steps below describe how to install the MPC-2240 VGA driver for Windows Embedded Standard 7.

1. On the software CD that shipped with your computer, go to the **Driver** folder and select **Win7**. Then, select either **32-bit** or **64-bit**, according to your platform. Then select the folder labeled **2.VGA**.

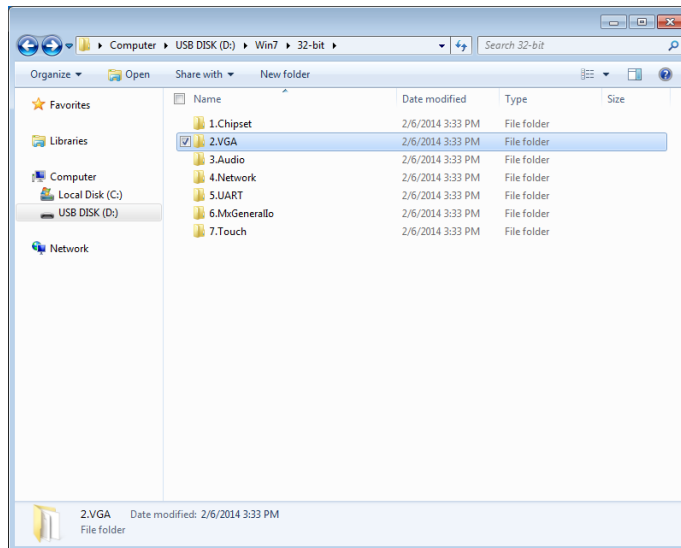

2. Double-click **Win32\_15319** to continue.

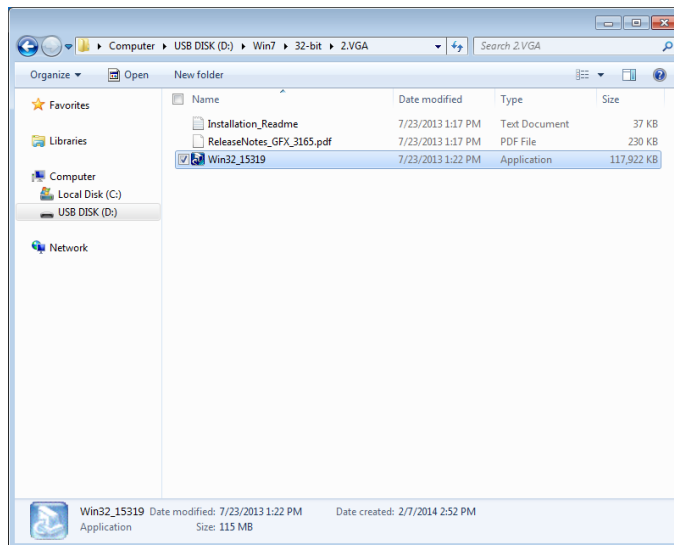

3. The installation wizard will launch; click **Next** to continue.

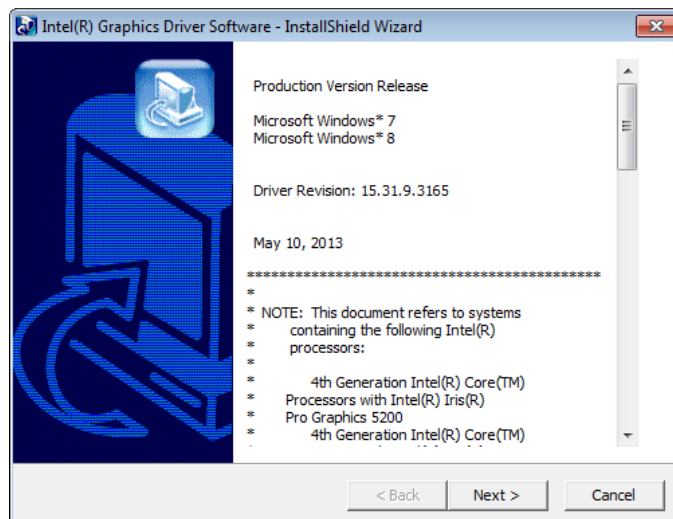

- Click **Next** to start the installation.

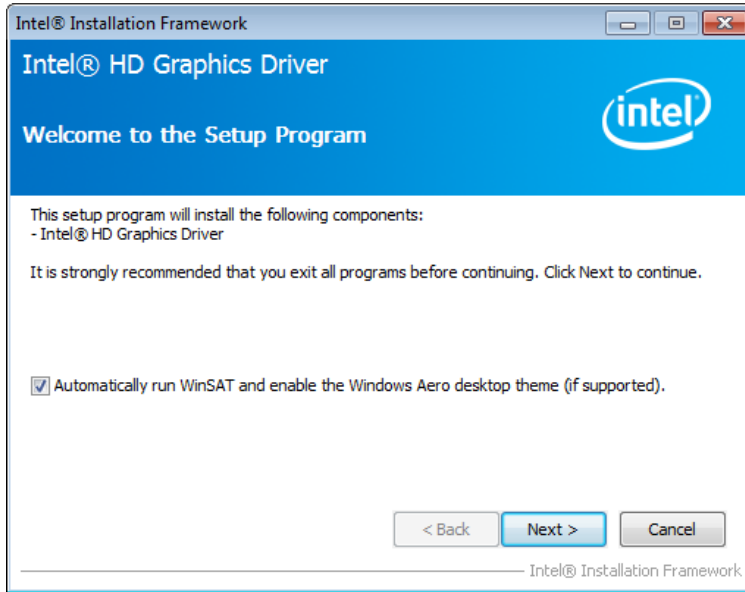

- Click **Yes** for the license agreement.

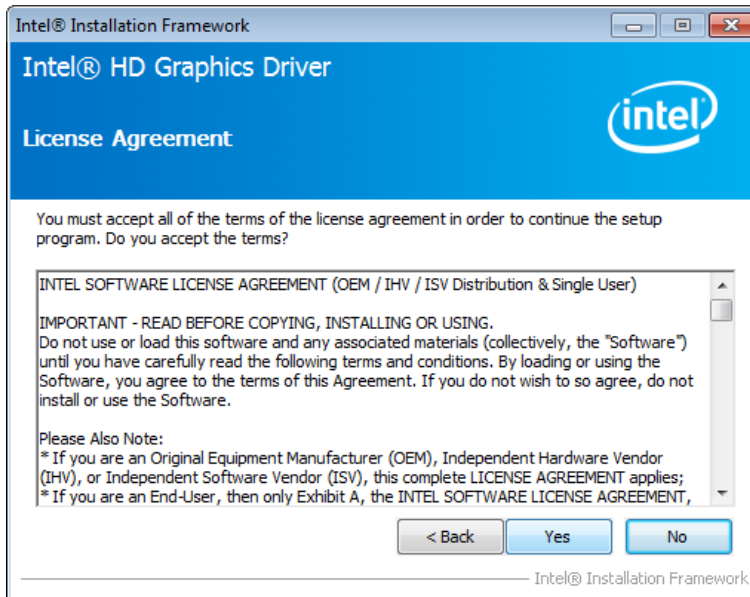

- Click **Next** to continue.

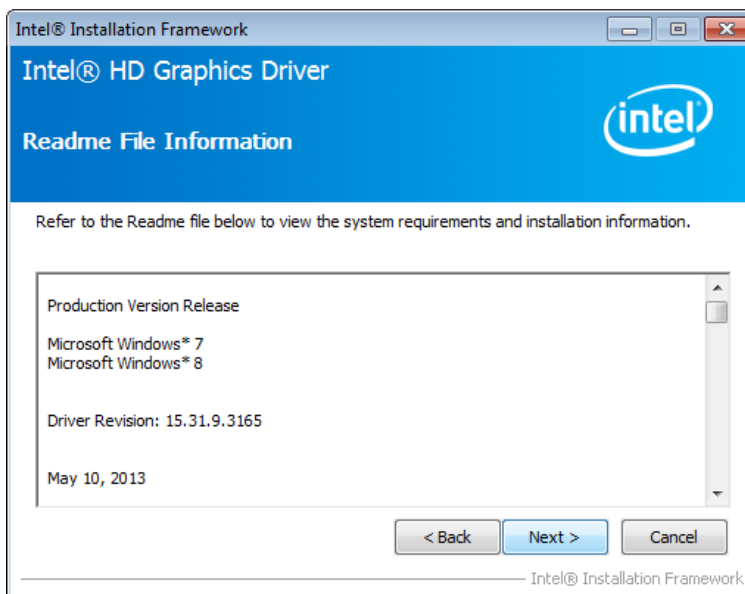

7. The installation will start. Wait until it finishes.

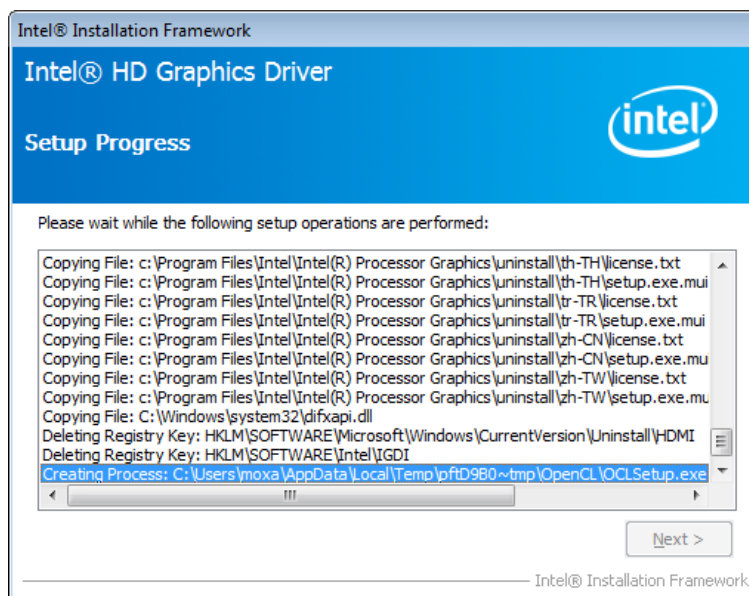
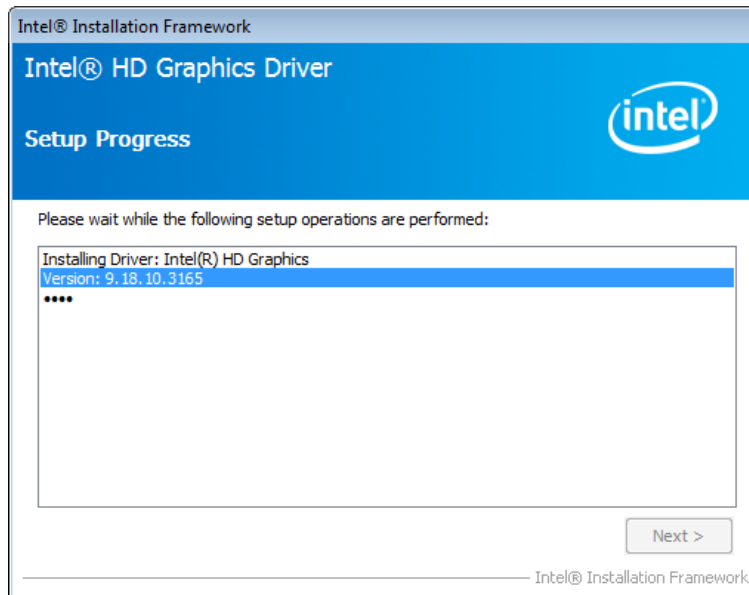

8. Click **Next** to continue.

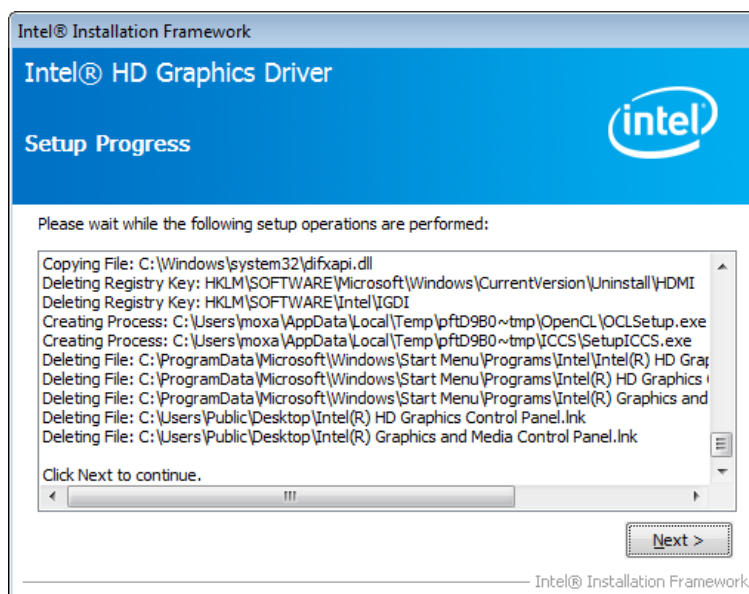

9. Select **Yes**, and then click **Finish** to complete the VGA driver installation.

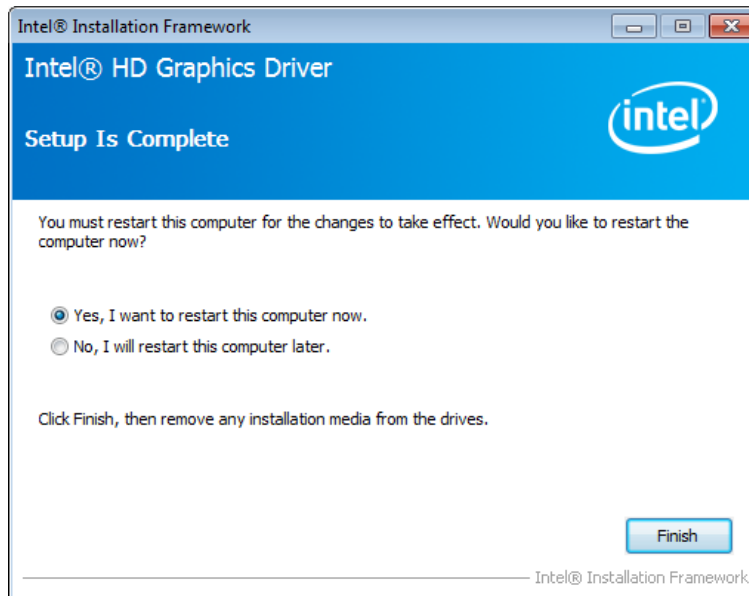

10. The MPC-2240 will restart, and you will now be able to adjust the display resolution with the tool provided by Intel.

## Adjusting Display Resolution

Follow these steps to adjust the display resolution.

1. Right-click the **Intel HD Graphics Control Panel** icon on the lower right corner of the screen, and select **Graphics Properties**.



2. Select **Display**.

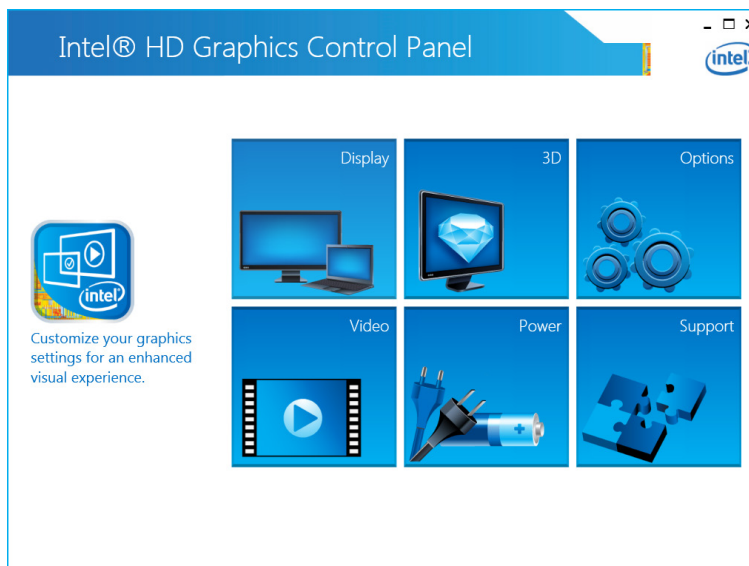

- Adjustments may be made to resolution, refresh rate, and image rotation. **Maintain Display Scaling** should be selected, so that the display can be maximized and fit the screen. Click **Apply** when finished.

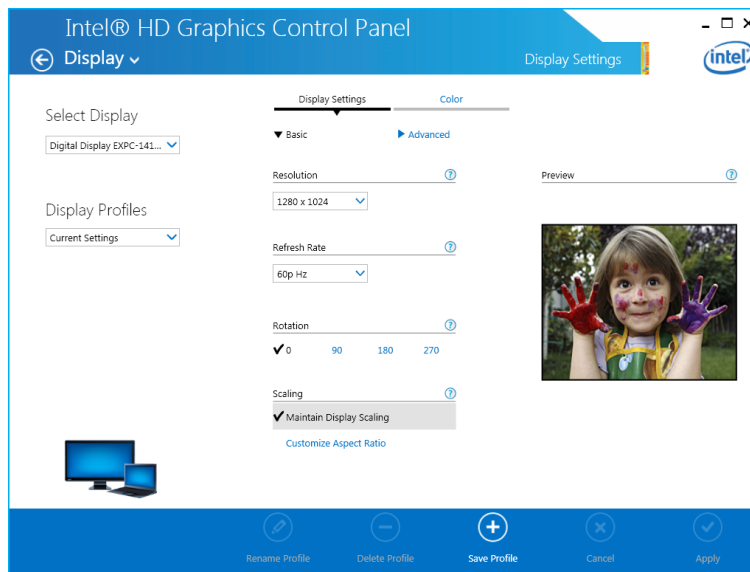

- Customize Aspect Ratio** is available to solve problems with aspect ratio and improper image scaling. To use it, adjust the image by manipulating the scrolling bars on the right.

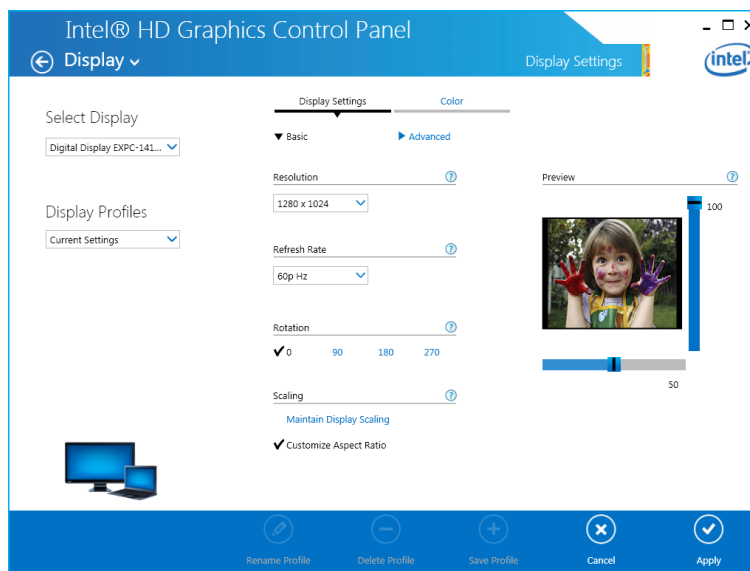

- Click **Apply** when finished.

## Installing the Touch Screen Driver

For touch screen models, you need to install the touch function driver. Follow these steps.

- In the Driver folder, select **7.Touch** folder.

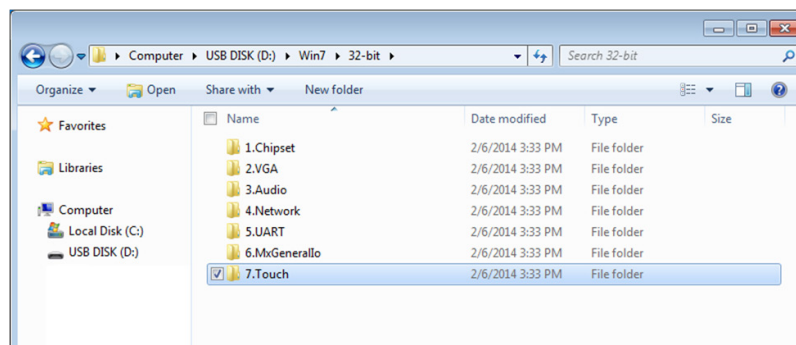

2. Select **eGalaTouch\_7\_Vista\_XP\_2K\_5.11.0.9126** folder.

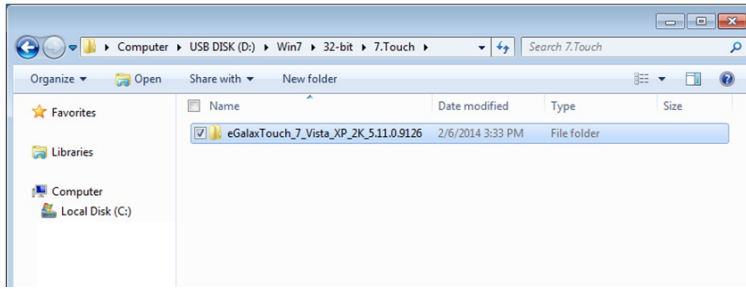

3. Select **eGalaxTouch\_5.11.0.9126** folder.

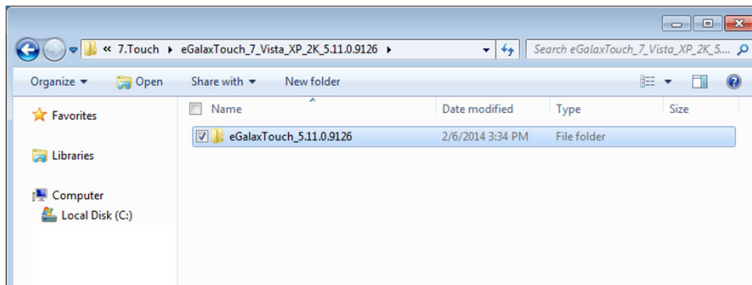

4. Select **setup** in the folder for the installation.

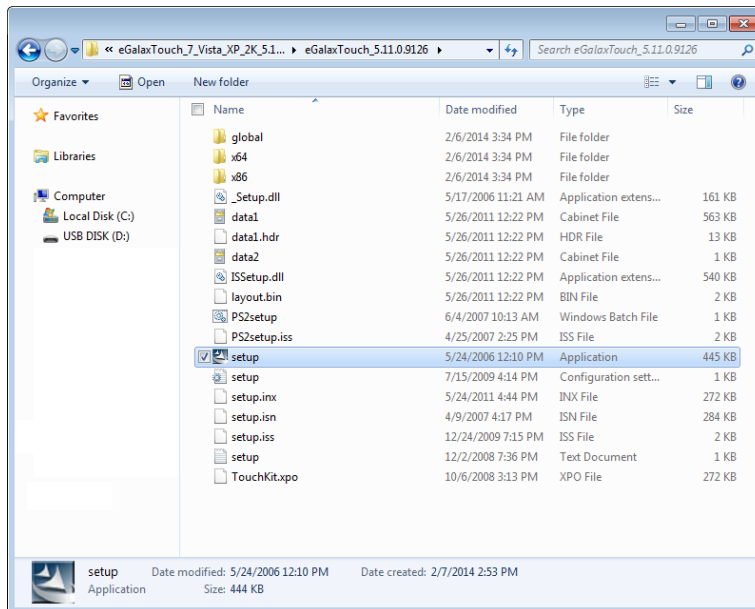

5. Click **Next** to continue.

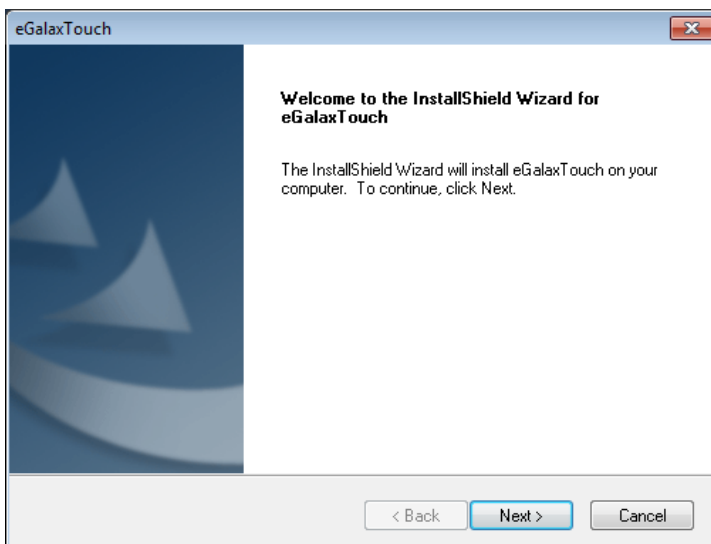

- 6. You do not need to check Install PS/2 interface drive. Click **Next** to continue.

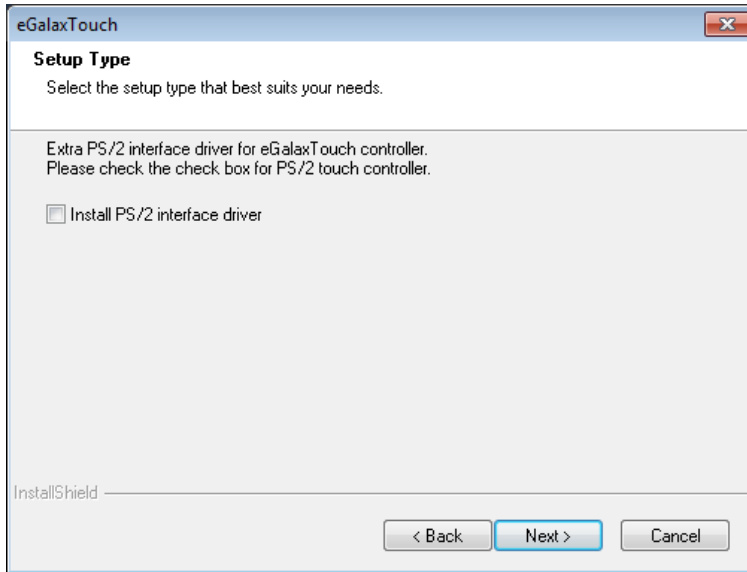

- 7. Check **Install RS232 interface drive**. Click **Next** to continue.

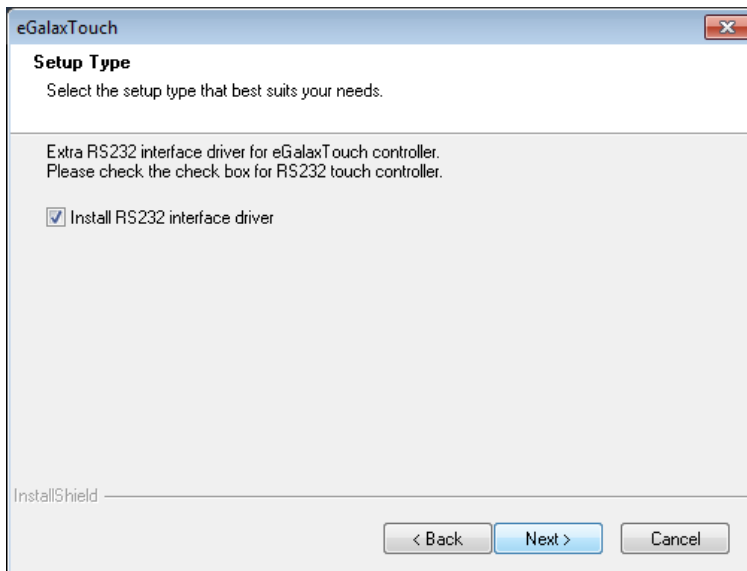

- 8. You may select the time to do touch screen calibration and then click **Next** to continue.

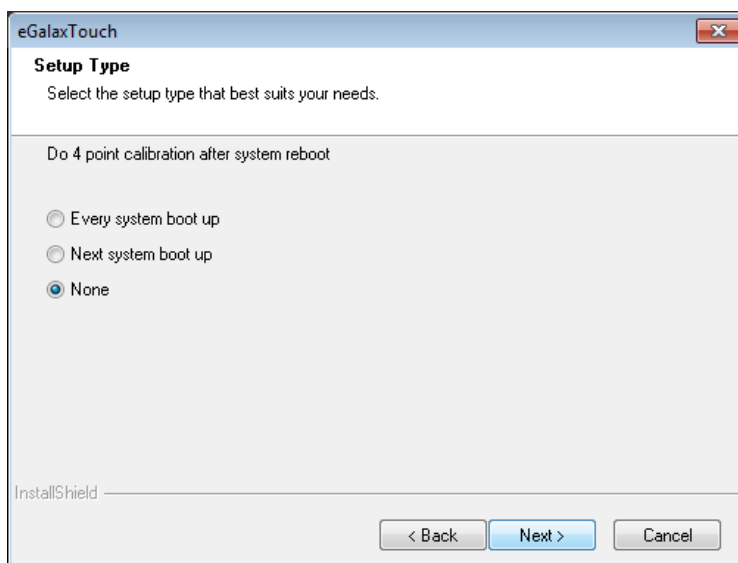



- To enable the touch screen, make sure your touch controller's USB cable is plugged in the MPC-2240. Click **OK** to continue.

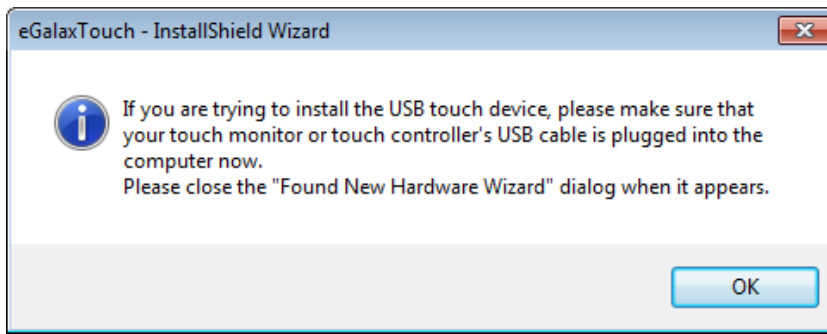

- You may check **Support Multit-Monitor System**, and then click **Next** to continue.

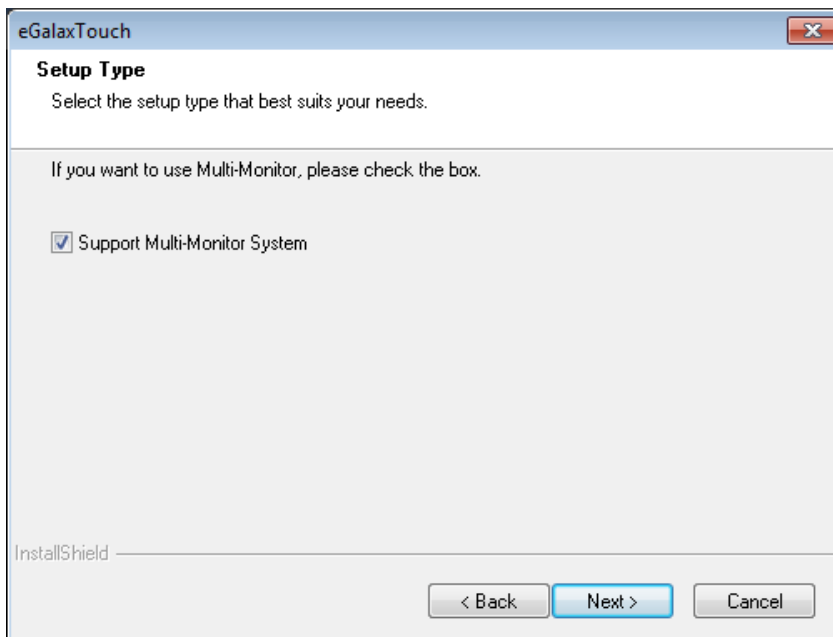

- You may select the destination folder by clicking **Browse**, and then click **Next**.

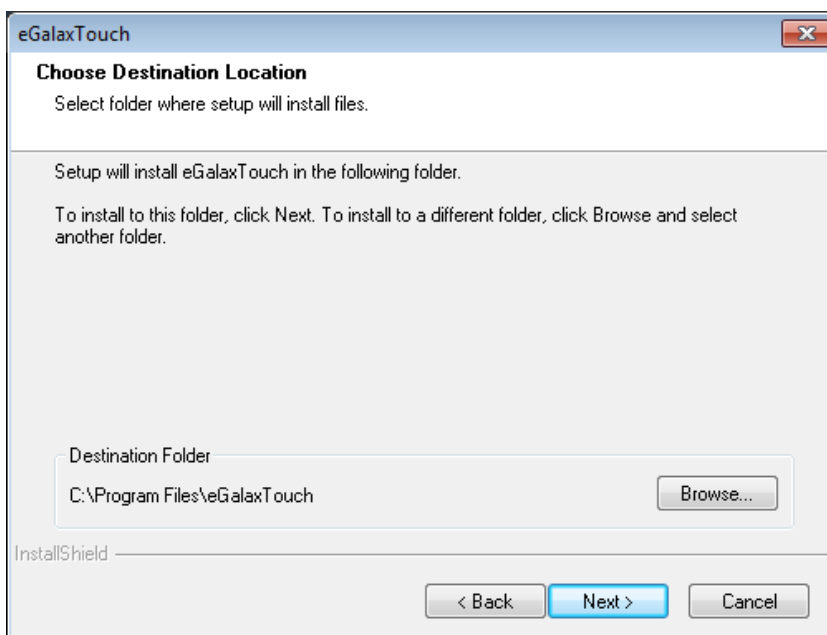

12. Click **Next** to continue.

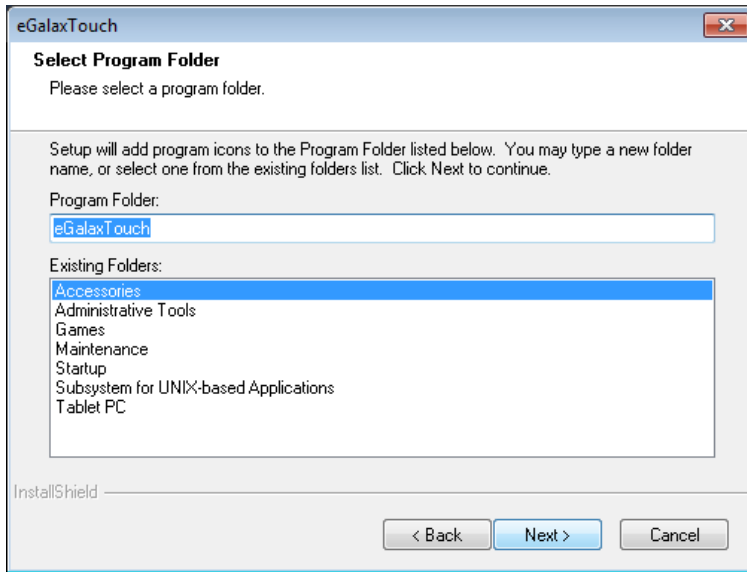

13. You may check **Create a eGalaxTouch Utility shortcut on desktop**. Click **Next** to continue.

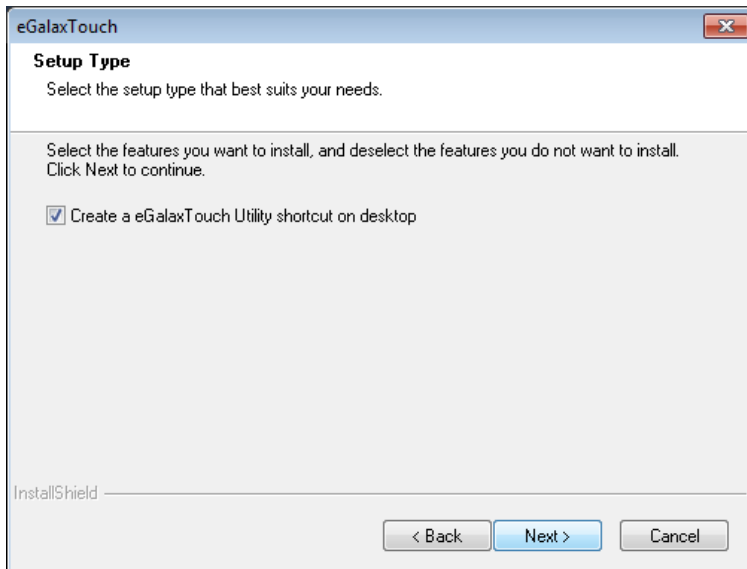

14. The installation will start, and wait until it finishes.

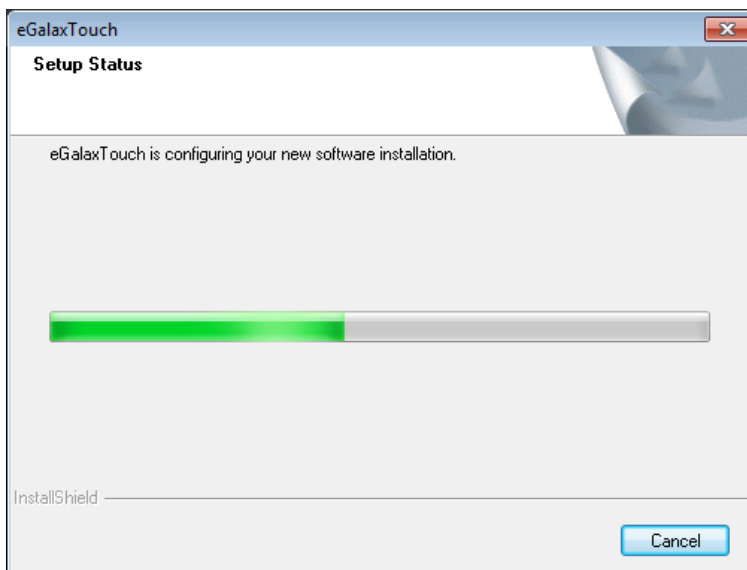

15. When finished, click **Yes**. You can do the 4 point calibration for the touch function.

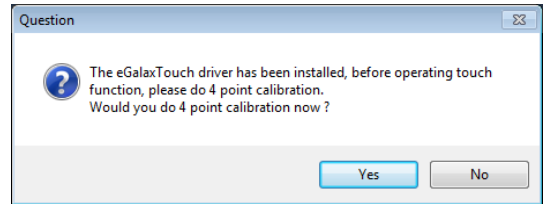

16. Four circles with crosshairs will appear in each of the four corners. One by one, touch the circle where the crosshairs meet and hold until the screen displays an **OK**. At that point, the circle should disappear; proceed to the next one, and do this consecutively each corner until all four have been calibrated.

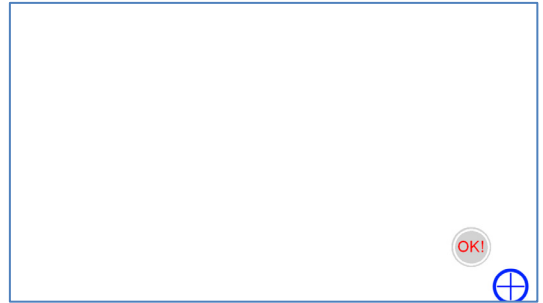

17. Click **OK** to complete.

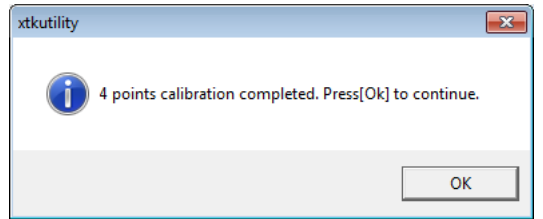

## Performing Screen Calibration

Please note that you need to do 4 points calibration whenever you change the display resolution, so that the touch function can work normally. Follow these steps.

1. Run **eGalaxTouch** by double-clicking the icon on the desktop.

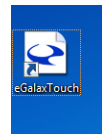

2. Select **Tools** tab, and click **4 Points Calibration** item.

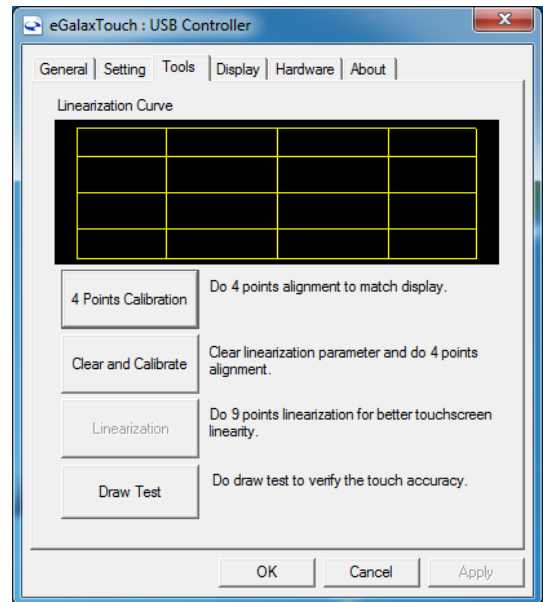

3. Four circles with crosshairs will appear in each of the four corners (shown at right). One by one, touch the circle where the crosshairs meet and hold until the screen displays an **OK** (as shown at right). At that point, the circle should disappear; proceed to the next one, and do this consecutively each corner until all four have been calibrated.



4. Click **OK** to complete the calibration.

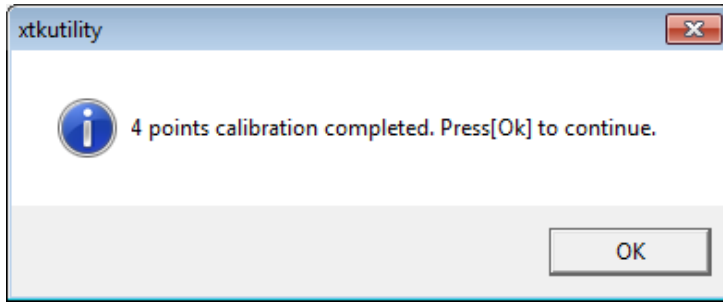

This chapter describes the BIOS settings of the MPC-2240 marine panel computer. The BIOS is a set of input/output control routines for peripherals. The BIOS is used to initialize basic peripherals and helps boot the operating system before the operating system is loaded. The BIOS setup allows the user to modify the system configurations of these basic input/output peripherals. All of the configurations will be stored in the battery backed up CMOS RAM, which retains the system information after system reboots or the power is removed.

The following topics are covered in this chapter:

- ❑ **Entering the BIOS Setup Utility**

- ❑ **Main Information**

- ❑ **Advanced Settings**

- Boot Configuration
- Peripheral Configuration
- HDC Configuration
- Video Configuration
- Chipset Configuration
- Hardware Monitor

- ❑ **Security Settings**

- Set Supervisor Password

- ❑ **Power Settings**

- ❑ **Boot Settings**

- Boot Type
- EFI Device First
- Boot Delay Time
- Legacy

- ❑ **Exit Settings**

- Exit Saving Changes
- Save Change Without Exit
- Exit Discarding Changes
- Load Optimal Defaults
- Load Custom Defaults
- Save Custom Defaults
- Discard Changes

- ❑ **Upgrading the BIOS**

## Entering the BIOS Setup Utility

To enter the BIOS setup utility, press the **F2** key while the system is booting up. The main **BIOS Setup** screen will appear. Select **SCU** to enter the **BIOS Configuration** screen.

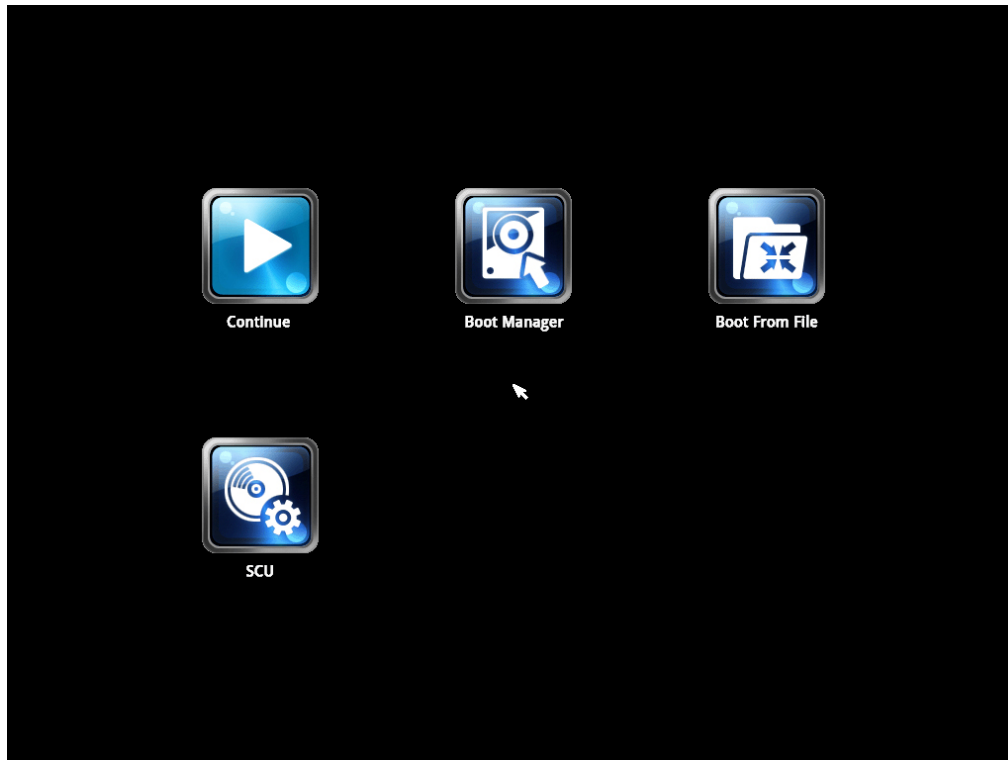
**NOTE**

The projected capacitive touch screen function is not supported in BIOS, please connect a keyboard to the MPC-2240 for BIOS configuration.

A basic description of each function key is listed at the bottom of the screen. Refer to these descriptions to learn how to use them.

**F1: General Help**

**F5/F6: Change Values**

**F9: Setup Defaults**

**F10: Save and Exit**

↑ ↓ : **Select Item**

← → : **Select Menu**

**ESC: Exit**

**ENTER: Select or go to Submenu.**

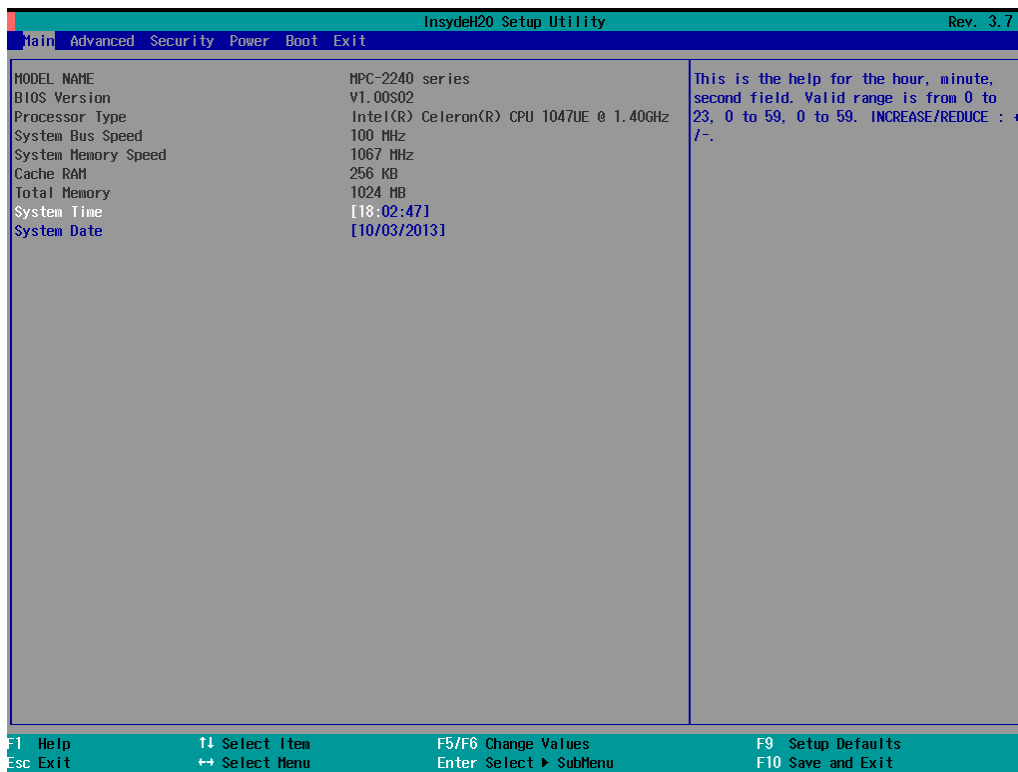

## Main Information

The main page indicates the system information, such as model name, BIOS version, and CPU type. User may view the basic system hardware information in the page.

## Advanced Settings

The "Advanced Features" screen will appear when choosing the "Advanced" item from the main menu.

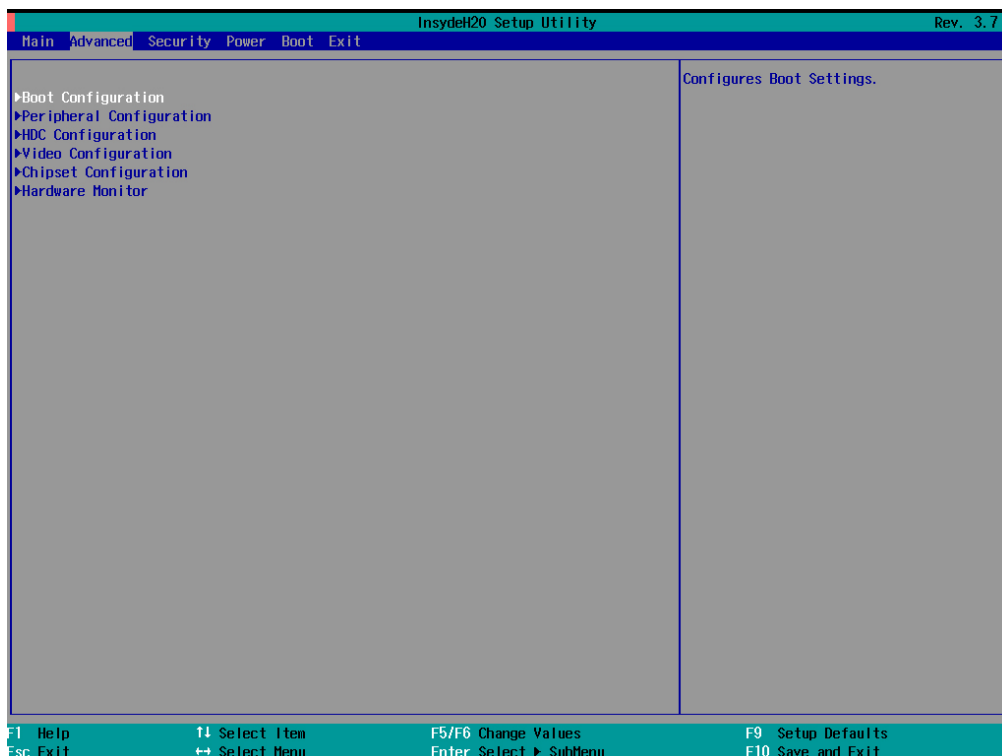

## Boot Configuration

This item allows users to configure the default value of Numlock.

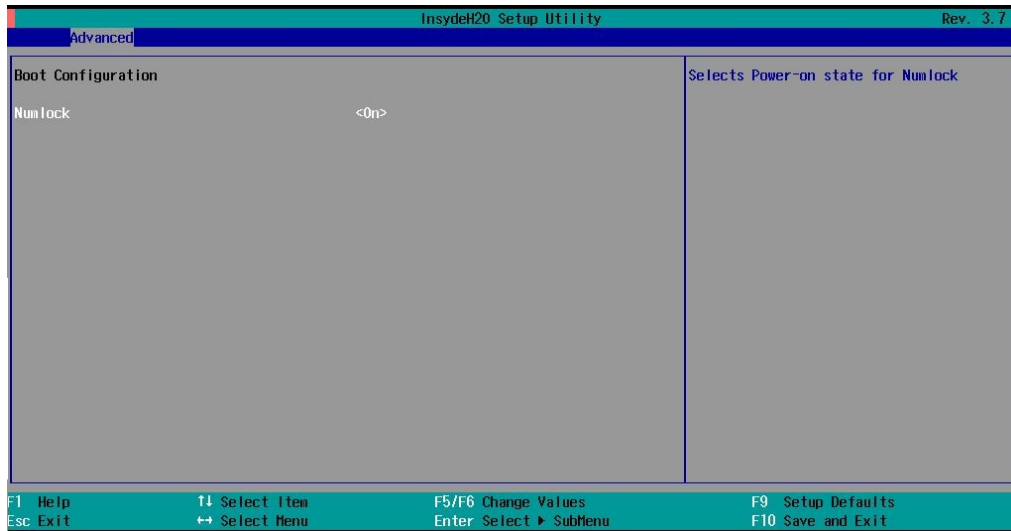

Option: On (default), Off.

## Peripheral Configuration

This item allows you to configure the parallel port.

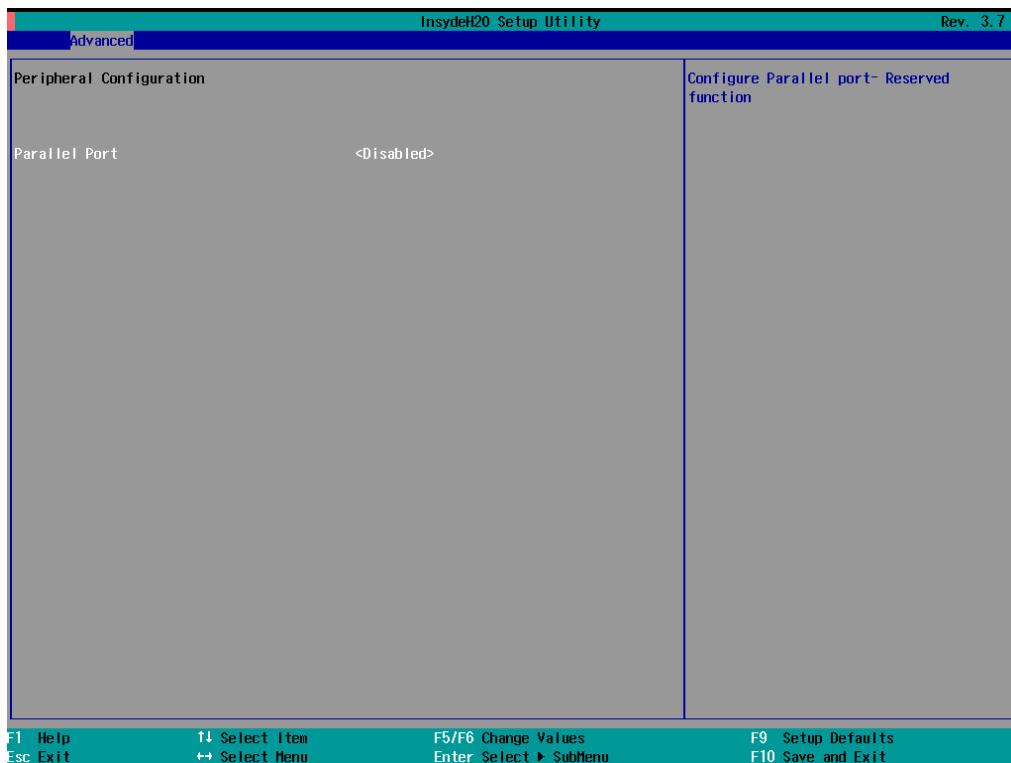

### Parallel Port

This item allows you to configure the parallel port.

Options: Disabled (default), 378/IRQ7



## Mode

This setting allows you to configure the mode for the parallel port.

Options: SPP (default), EPP, ECP, EPP+ECP

## HDC Configuration

The host drive controller may be configured for IDE (legacy default), or AHCI mode.

When the legacy IDE mode is selected, the following screen will appear.

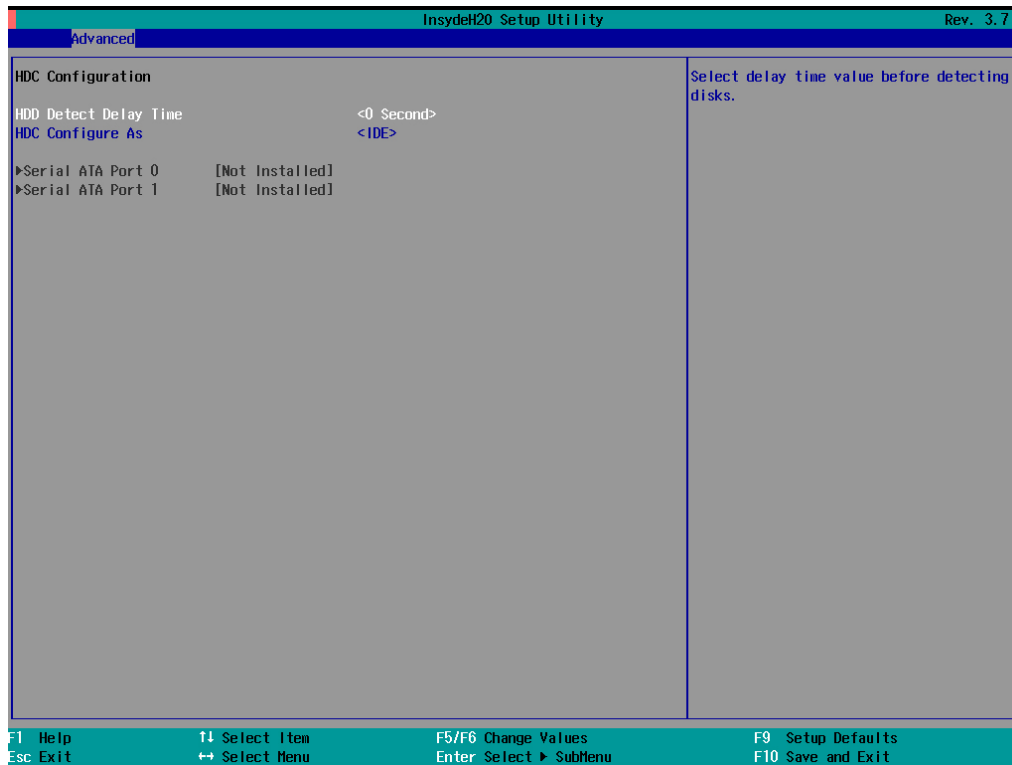

## HDD Detect Delay Time

This setting allows you to configure the delaying time value before detecting the hard disks.

Option: 0 (default), 1, 2, 3 seconds.

## Serial ATA Port 0 to 1

This setting allows you to display information about the installed drives.

## AHCI SALP

Please note that AHCI SALP will only appear when AHCI mode is selected. This item allows you to enable **Aggressive Link Power Management** (SALP) in AHCI. SALP enables the host bus adapter to conserve power by directly detecting when a SATA drive is no longer processing information and then immediately shifting it into suspended or sleep modes without waiting for software processes to initiate power-down processes. Host Capability Register bit 26.

Options: Enabled (default), Disabled

## SATA Port 0 to 1 - HotPlug

This item allows you to enable/disable hotplug capabilities (the ability to remove the drive while the computer is running) for installed storage drives.

Options: Disable (default), Enabled

## Video Configuration

This item allows you to configure the integrated graphics device (IGD) for things like memory allocation (**DVMT**) and monitor types (**Boot Type**).

### Internal Graphics Device

This option allows you to enable/disable the internal graphics device.

Options: Enable (default), Disable

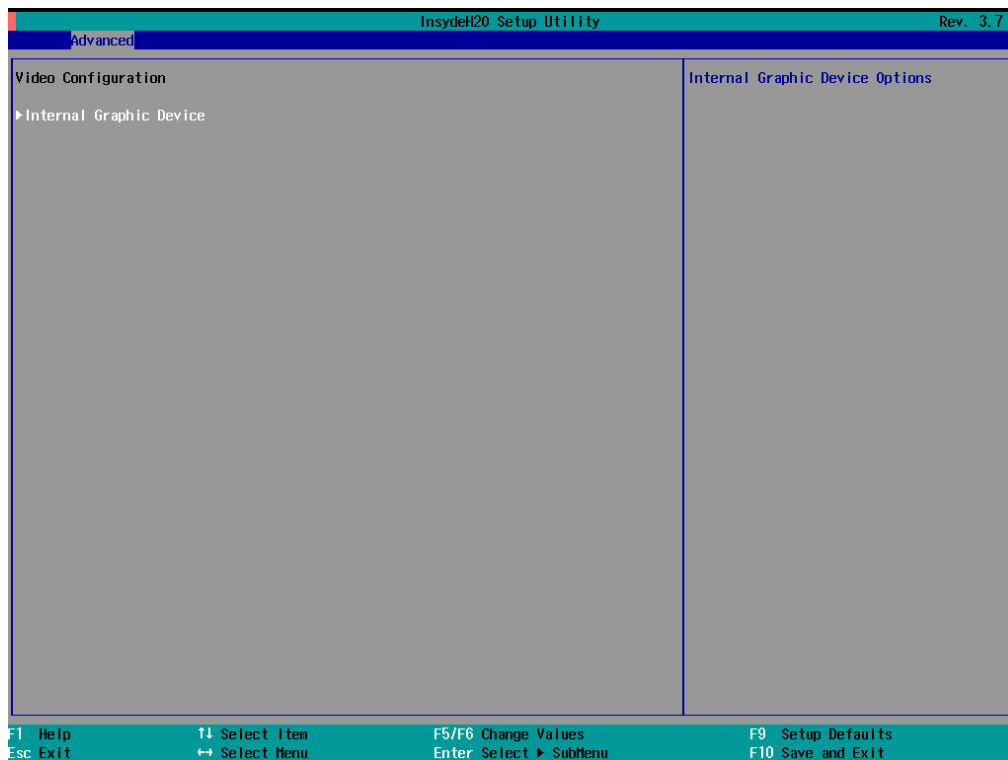

### IGD—DVMT Pre-Allocated

This item allows you to configure pre-allocated memory capacity for the IGD. Pre-allocated graphics memory is invisible to the operating system.

Options: 64 MB (default), 32 MB, 96 MB, 128 MB, 256 MB, 512 MB

**DVMT** is a BIOS solution where "the optimum amount of memory is dynamically allocated and de-allocated as needed for balanced graphics and system performance, through Intel® Direct AGP and a highly efficient memory utilization scheme. DVMT ensures the most efficient use of available system memory resources for maximum 2D/3D graphics performance.

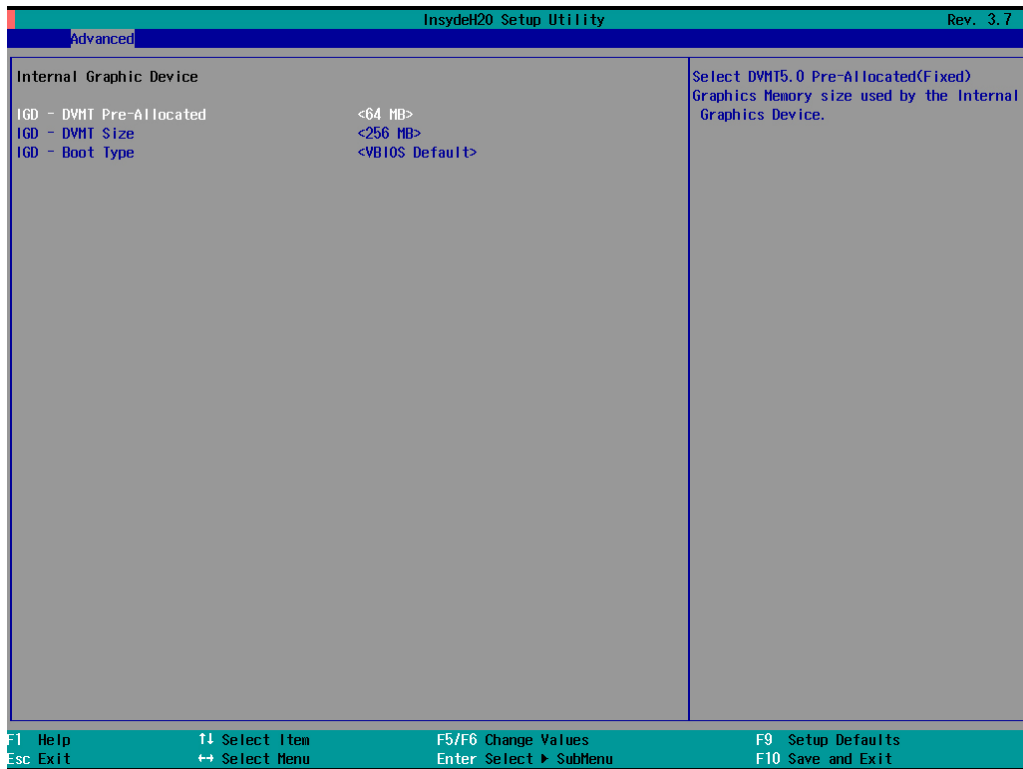

## IGD—DVMT Size

This item allows you to configure the maximum amount of memory DVMT will use when allocating additional memory for the internal graphics device.

Options: 256 MB (default), 128 MB, Max

## IGD – Boot Type

This item allows you to select the video device which will be activated during POST.

Options: VBIOS Default (default), VGA, DVI-D2, DVI-D1

## Chipset Configuration

This item allows you to configure the chipset settings.

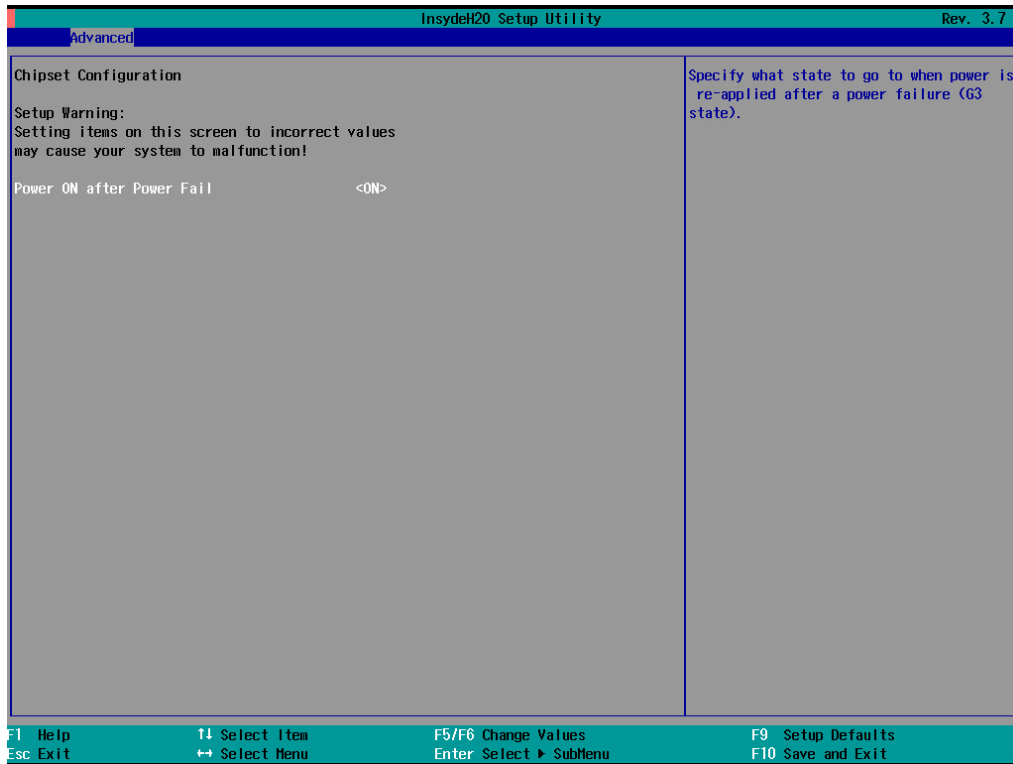

### Power ON after Power Fail

This item allows you to enable/disable the computer from automatically powering up after a system crash.

Options: ON (default), OFF, Last State

## Hardware Monitor

This item allows you to view stats like CPU and system temperature, voltage levels, and other chipset information. Please note that the CPU fan will not start until the temperature is above 80 degrees Celsius.

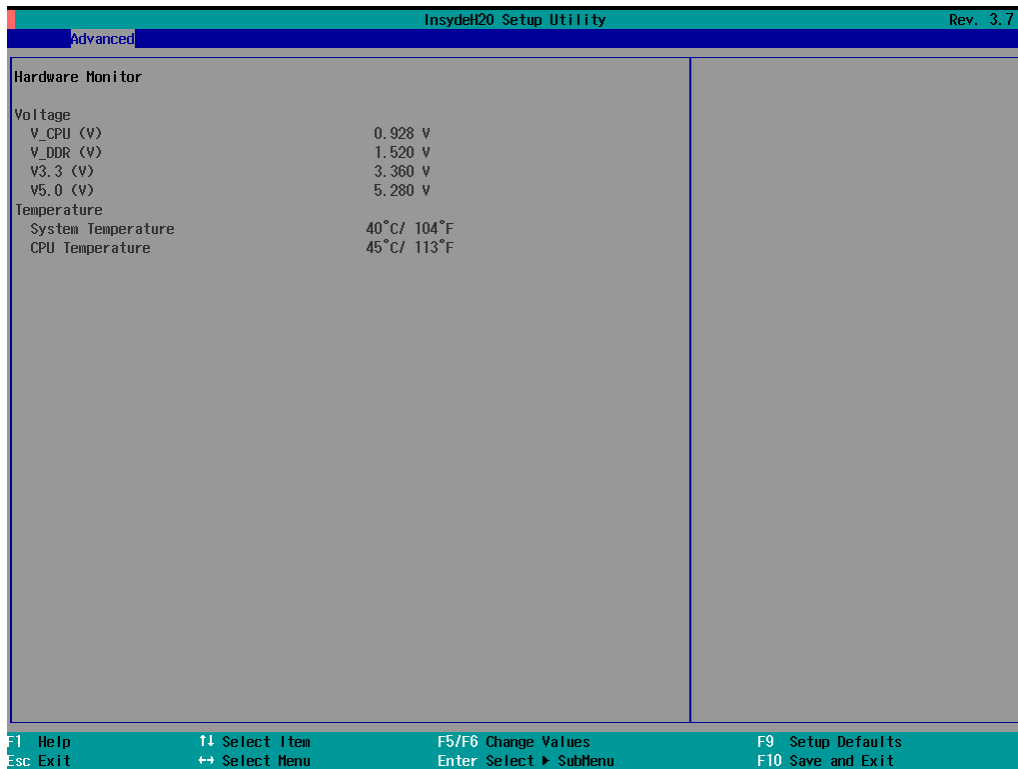

## Security Settings

This section allows users to configure security settings with a supervisor password and user password.

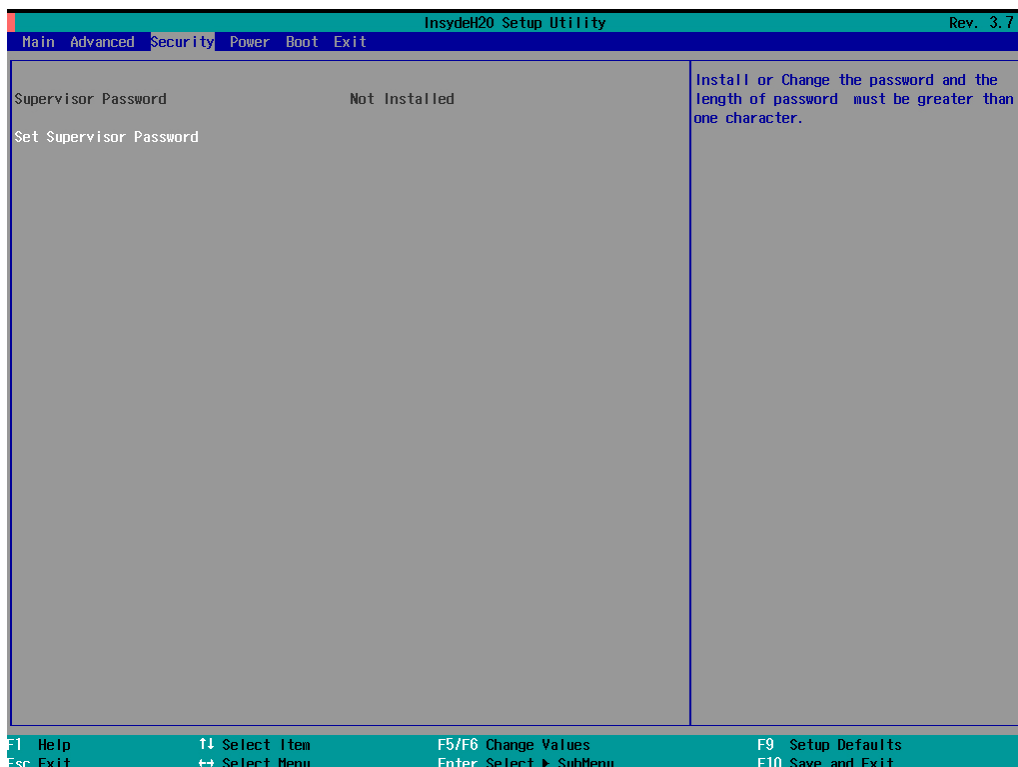

## Set Supervisor Password

This item allows you set the supervisor password. Select and then enter the password, and then confirm the password again.

To delete the password, enter **Set Supervisor Password** and then enter the old password; then, leave the new password fields blank, and press enter.

## Power Settings

The section allows users to configure power settings.

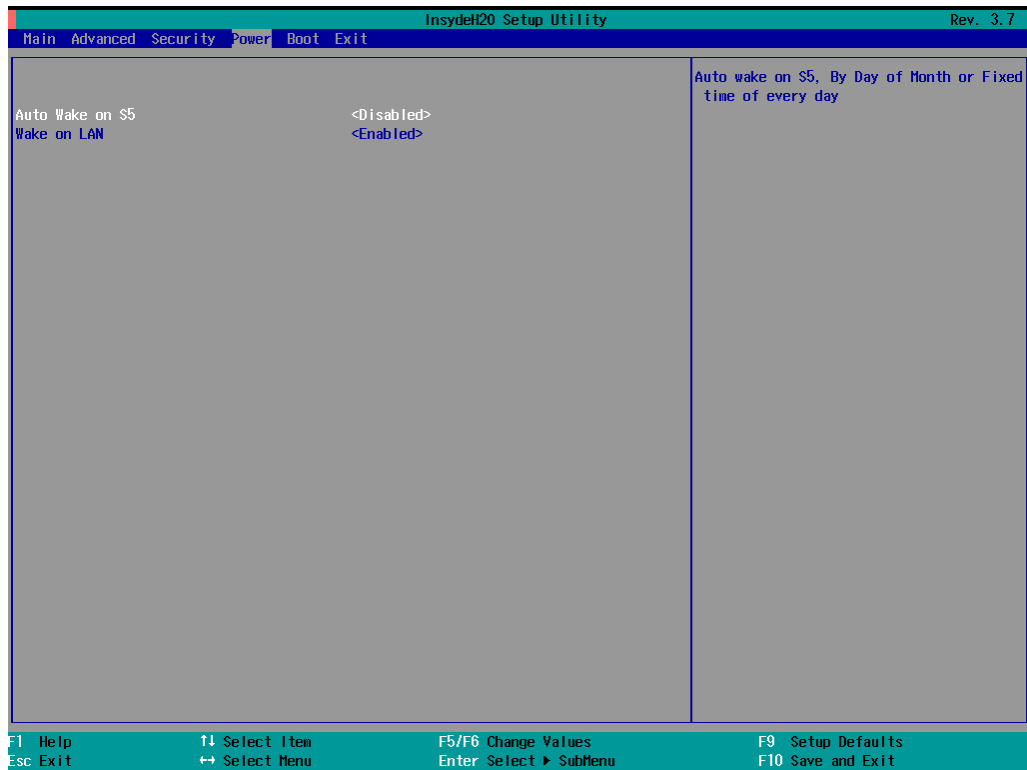

# Boot Settings

The section allows users to configure boot settings.



## Boot Type

This item allows you to enable/disable quick boot function.

Options: Dual Boot Type (default), Legacy Boot Type, UEFI Boot Type.

## PXE Boot to LAN

This item allows you to enable/disable PXE boot to LAN function.

Options: Disabled (default), Enabled

## Add Boot Options

This item allows you to add the boot order options for shell, network and Removables.

Options: Last (default), First

## USB Boot

This item allows you to enable/disable USB boot function..

Options: Enabled (default), Disabled

## EFI Device First

This item allows you to determine EFI device first or legacy device first. If enabled, EFI device will be the first; if disabled, legacy device will be the first.

Options: Disabled (default), Enabled

## Boot Delay Time

This item allows you to configure the delay time value for users to input hot key during POST time.

Options: 0 Second (default), 3 Seconds, 5 Seconds, 10 Seconds

## Legacy

### Normal Boot Menu

This item allows you to configure the boot menu.

Options: Normal (default), Advance

### Boot Type Order

This item allows you to select the boot order. Use F5/F6 to change values.

Options: Hard Disk Drive (default), CD/DVD-ROM Drive, USB, Others

### Hard Disk Drive/USB Drive

This item allows you to view installed devices such as hard disk drives, USB drives, or CD-ROMs. For example, if you have inserted a USB drive into the computer, it will appear here.



# Exit Settings

The section allows users to exit the BIOS environment.



## Exit Saving Changes

This item allows you to exit the BIOS environment and save the values you have just configured.

Options: Yes (default), No

## Save Change Without Exit

This item allows you to save changes without exiting the BIOS environment.

Options: Yes (default), No

## Exit Discarding Changes

This item allows you to exit without saving any changes that might have been made to the BIOS.

Options: Yes (default), No

## Load Optimal Defaults

This item allows you to revert to the factory default BIOS values.

Options: Yes (default), No

## Load Custom Defaults

This item allows you to load custom default values for the BIOS settings.

Options: Yes (default), No

## Save Custom Defaults

This item allows you to save the current BIOS values as a “custom default” that may be reverted to at any time by the “load custom defaults” selection just above.

Options: Yes (default), No

## Discard Changes

This item allows you to discard all settings you have just configured.

Options: Yes (default), No

## Upgrading the BIOS

This section describes how to upgrade the BIOS. However, please note that it is easy to permanently damage the computer when upgrading the BIOS. We strongly recommend that you contact Moxa’s technical support staff for assistance in order to obtain all necessary tools and the most current advice before attempting to upgrade the BIOS on any Moxa device.

### Step 1: Create a Bootable USB Disk

Before upgrading the BIOS every user should first create a bootable USB RAM drive as a system rescue device. You may use any software that can create a bootable USB drive. In this section, we use Rufus, which may then be downloaded and used to create a bootable RAM drive, as an example. Do the following steps to create a bootable USB disk by using Rufus.

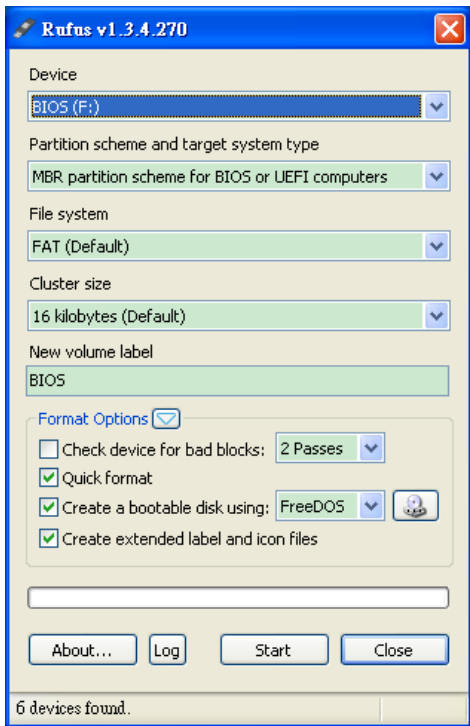
<ol style="list-style-type: none"> <li>1. Start the Rufus and in Device drop-down list select the USB device that you want to use as a bootable disk.</li> <li>2. Select <b>MBR partition scheme for BIOS or UEFI computers</b>, let it can boot from legacy BIOS or UEFI.</li> <li>3. Select <b>FAT (Default)</b> from File system drop-down list.</li> <li>4. Select <b>16 kilobytes (Default)</b> for Cluster size.</li> <li>5. Enter a drive name in New volume label.</li> <li>6. Check <b>Quick format</b>, <b>Create a bootable disk using FreeDOS</b>, and <b>Create extended label and icon files</b>.</li> <li>7. Click <b>Start</b> to format and create the bootable USB drive.</li> </ol>	
--	--



### ATTENTION

We suggest you use a USB drive with under 2 GB in disk space, as larger USB drives may not support FAT file format and consequently fail to boot.

## Step 2: Prepare the Upgrade File

You must use the BIOS upgrade installation file to upgrade the BIOS. Contact Moxa's technical department for assistance.

1. Get the BIOS upgrade installation file. The file name should have following format: **2240xxSx.exe** (xx refers to version numbers).
2. Copy the file to the Bootable USB Disk.

## Step 3: Run the upgrade program on the MPC-2240 Series Panel Computer

1. Reboot the computer, press F2 while booting up to go to the Boot Manager
2. Select USB Disk as the first boot source. Press Enter to continue.

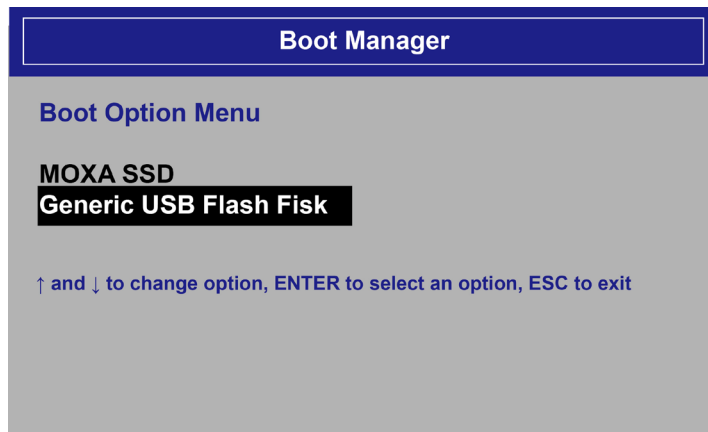

3. When boot up finishes, DOS screen will show up. Go to the directory where the upgrade file is located. For example, if the upgrade file is stored in the MPC2240 folder, type **cd MPC2240**.

```
C:\cd MPC2240
```

4. Run the upgrade program by typing **22410S02.exe**. Please note that the upgrade filename may vary depending on the versions.

```
C:\MPC2240>22410S02.exe
```

5. The upgrade program will be automatically performed. Please wait until the procedure to be finished.

```

C:\>22410S02.exe
Reading file...
flash package mode.
Option: -BIOS -C -Desc -ME

```

**Please do not remove the AC power!**

```

Insyde Flash Utility for InsydeH20
Version 1.5t

Initializing

Current BIOS Model name: MPC-2240
New BIOS Model name: MPC-2240

Current BIOS version: V1.00S02
New BIOS version: V1.00S02

Updating Block at FFDE8000

```

6. When the upgrade is finished, the computer will automatically reboot. You may check the BIOS version in Main page of the BIOS Setup

MODEL NAME	MPC-2240
BIOS Version	V1.00S02
Processor Type	Intel (R) Celeron (R) CPU 1047UE @ 1.40GHz

**ATTENTION**

Do NOT switch off the power supply during the BIOS upgrade, since doing so may cause the system to crash.

# Display Control Interface

---

The MPC-2240 comes with a UART interface that gives system designers a convenient means of coding custom software controls for the display panel. This chapter describes the details of the UART control interface and the format of the available commands.

The following topics are covered in this chapter:

- ❑ **Connecting to Display Control Interface**
- ❑ **UART Command Format**
  - Command Format Description
- ❑ **Downloading RGB Files**

## Connecting to the UART Control Interface

The control interface of the MPC-2240 is accessed over the COM3 serial port. A Telnet terminal (like Moxa's Moxa's PComm terminal emulator, or PuTTY) should be used to communicate with the display.

When launching a terminal emulator you will need to configure the connection. Below, we show you how to configure an emulator using Moxa's PComm terminal emulator. The relevant connection settings are shown in steps 2 and

1. Select **Port Manager**, and then select **Open**.

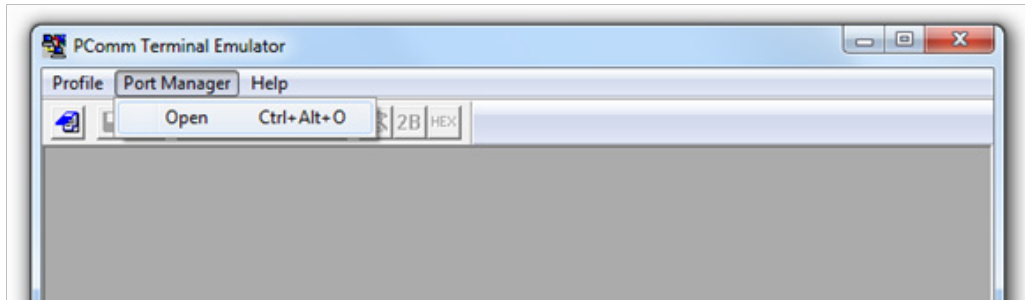

2. Connection settings are shown below. When finished, click **OK**.

**Protocol:** Serial

**Serial Parameters:** COM3

**Baud rate:** 9600

**Data bits:** 8

**Parity:** None

**Stop bits:** 1

**RTS state:** ON

**DTR state:** ON

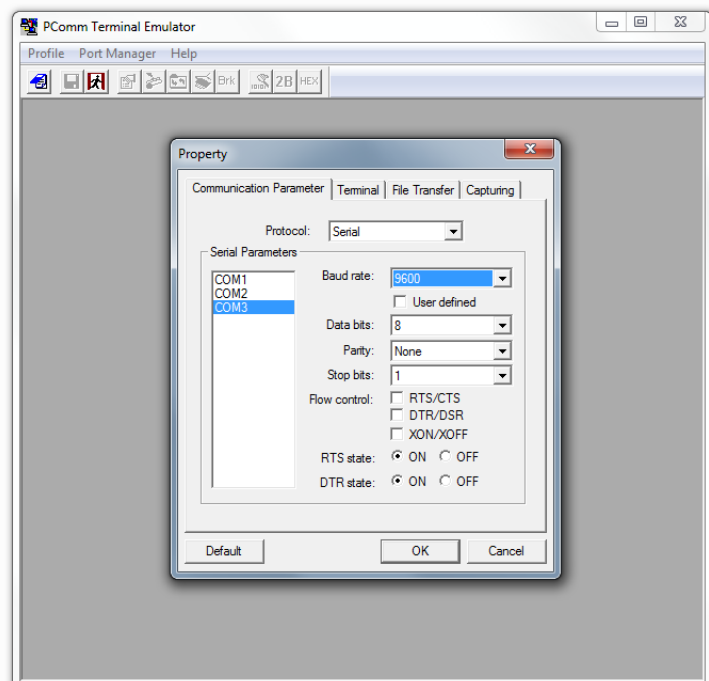

3. After successfully connecting, select **Send pattern** tab.

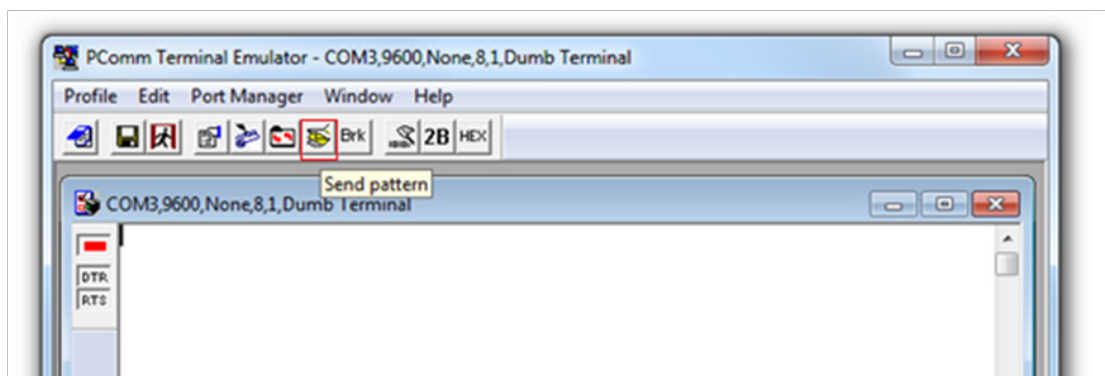

- Now you may enter a command in the **HEX** field, and click **Start Send** to send the command.

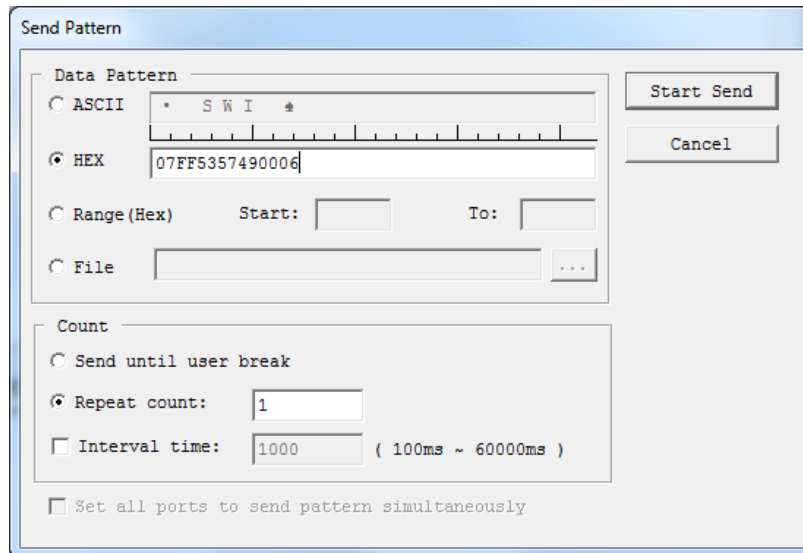

This example is to query the firmware version on the scalar board.

**Example: Querying the scalar board’s firmware version**

0x07	0xFF	0x53	0x57	0x49	0x00	0x06
------	------	------	------	------	------	------

For detailed command explanations, please refer to **Appendix B: UART Commands for Display Control**.

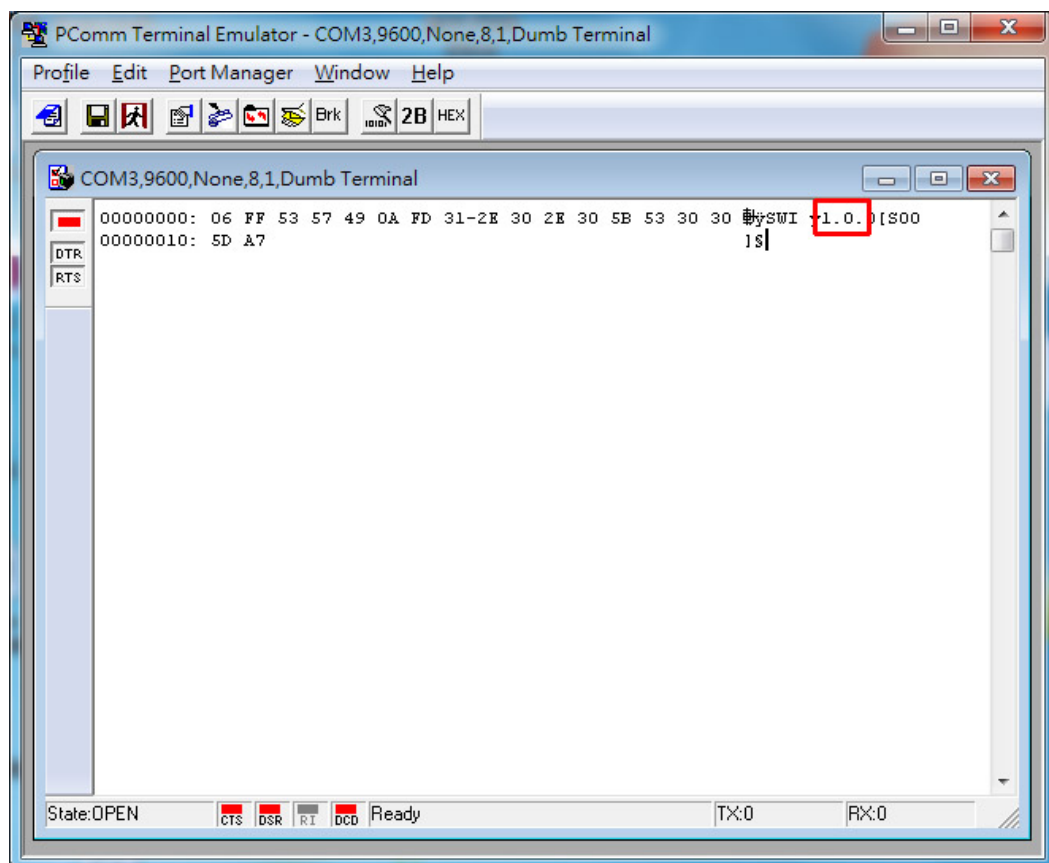

You may see the scalar firmware version 1.0 in the screen.

## UART Command Format

The message format is as follows:

Byte #	0	1	2,3,4	5	6	7 + (LEN-1)	7+LEN
	ATTN	ADDR	CMD	LEN	IHCHK	DATA	IDCHK

The minimum message size is 7 bytes, and the maximum size is 82 bytes.

## Command Format Details

### ATTN (Attention)

This byte is used to identify a start of message, and it can be one of three values:

ATTN	Description
0x07	Command (ASCII BELL) packet
0x06	Acknowledge (ASCII ACK) packet
0x15	Negative ACK (ASCII NAK) packet

A device shall send a command using the 0x07 Attention Code. The unit will respond to the command with either an ACK if the command completed successfully, or a NAK if the command failed.

### ADDR (Address)

This byte is used to specify the address where a command will be sent. Please note that the MPC-2240 only supports a broadcast address, so the address field only uses the following value:

ADDR	Description
0xFF	Broadcast the command to all units

### CMD (Message Commands and Queries)

The command portion of the message will be one of the following values. For details, refer to [Appendix B: UART Commands for Display Control](#).

CMD 0	CMD 1	CMD 2	ASCII	Description
0x42	0x52	0x49	BRI	Sets minimum possible brightness for the display panel
0x42	0x52	0x4D	BRM	Sets maximum possible brightness for the panel
0x42	0x52	0x54	BRT	Restricts the brightness range for the display panel
0x42	0x4C	0x49	BLI	Sets the panel brightness.
0x50	0x4F	0x54	POT	[DISABLED]
0x45	0x54	0x43	ETC	Queries the system uptime
0x42	0x5A	0x5A	BZZ	Buzzer control
0x44	0x4C	0x4E	DLN	Returns a copy of the ECDIS RGB file from the EEPROM
0x44	0x4C	0x3F	DL?	Queries the size of the ECDIS RGB file
0x45	0x4D	0x53	EMS	Sets the ECDIS brightness mode
0x42	0x52	0x55	BRU	Sets LED brightness for the display controls
0x42	0x52	0x4C	BRL	Sets LED brightness for the display controls
0x47	0x4D	0x42	GMB	Sets minimum possible brightness for display controls
0x53	0x57	0x4B	SWK	Queries the display controls' firmware version
0x53	0x57	0x49	SWI	Query the firmware version of the scalar board
0x41	0x44	0x46	ADF	Detects if the AC power input is connected
0x41	0x44	0x3F	AD?	Returns whether AC detection is enabled or disabled
0x44	0x55	0x46	DUF	This disables all or selected UART commands; if all are disabled, the machine is reset to factory defaults

### LEN (Data Length)

This byte defines the length of data in the message in bytes. The maximum value for this field is 74 bytes, and the minimum value is 0.

### IHCHK (Inverse Header Checksum)

This is a simple 8-bit checksum of the first six bytes of the packet (bytes 0 to 5) after a bitwise inversion has been performed on them. This means the 8-bit sum (without carrying) of bytes 0, 1, 2, 3, 4, 5, and 6 is **0xFF**.



$$IHCHK = 0xFF - [\text{the sum of bits } 0, 1, 2, 3, 4, 5]$$

If a message is received with an incorrect checksum, the display will resend the message with the attention code (byte 0) set to NAK, unless it is a broadcast message in RS-485, in which case there will be no NAK.

## DATA (Data Field)

The data field must have a LEN larger than 0; some commands do not have any data, so this field is left blank.

## IDCHK (Inverse Data Checksum)

This is a simple 8-bit checksum of the data field, message bytes 7 to 7+ (LEN-1) after a bit-wise inversion has been performed on each bit. This means that the IDCHK bit is equal to 0xFF - the sum of all data bits:

$$IDCHK = 0xFF - [\text{the sum of bits } 7 \text{ to } 7+[\text{LEN}-1]]$$

If the message carries no data, then this checksum is not transmitted.

Except for broadcast messages in RS-485 (see above, IHCHK), if a message is received with an incorrect checksum, the display will resend the message with the attention code (byte 0) set to NAK.

If included, this bit will always be the final bit in a packet.

# Downloading RGB Files

This feature returns the ECDIS RGB file that is currently saved to the EEPROM; consequently, it is only available for type-approved ECDIS models.

Use the following commands for downloading RGB files.

Command	Description
<b>DL?</b>	Data: none (0 byte) ACK: Total packet numbers (1 byte)
<b>DLN</b>	Data: Appointed packet (1 byte) ACK: File content (30 bytes maximum, except for the last packet)

The command **DL?** will send a request to the micro controller and ask how many packets that need to be downloaded. The reply from the micro controller shall be used when using the command **DLN** to download the specific packets. Refer to the following section for detailed descriptions of the **DL?** and **DLN**.

### Query the RGB File Size (in packets): DL? Command

	Byte 0	Byte 1	Byte 2	Byte 3	Byte 4	Byte 5	Byte 6
<b>Hex</b>	0x7	0xFF	0x44	0x4C	0x3F	0x0	0x2A
<b>ASCII</b>			D	L	?		

### Download the RGB File: DLN Command

	Byte 0	Byte 1	Byte 2	Byte 3	Byte 4	Byte 5	Byte 6	Byte 7	Byte 8
<b>Hex</b>	0x7	0xFF	0x44	0x4C	0x4E	0x1	0x1A	0x50	0xAF
<b>ASCII</b>			D	L	N				

Here is sample command to read and return packet zero of the RGB file:

0x07	0xFF	0x44	0x4C	0x4E	0x01	0x1A	0x00	0xFF		
------	------	------	------	------	------	------	------	------	--	--

And this is the ACK packet that is returned, with data packet 0 located in the **Data** section.

0x06	0xFF	0x44	0x4C	0x4E	0x20	0xFC	0x00	-	<b>Data</b>	IDCHK
------	------	------	------	------	------	------	------	---	-------------	-------

Data should be the real value of the RGB file package 0.

# A

## Regulatory Approval Statement

---



This device complies with part 15 of the FCC Rules. Operation is subject to the following two conditions: (1) This device may not cause harmful interference, and (2) this device must accept any interference received, including interference that may cause undesired operation.

Class A : FCC Warning! This equipment has been tested and found to comply with the limits for a Class A digital device, pursuant to part 15 of the FCC Rules. These limits are designed to provide reasonable protection against harmful interference when the equipment is operated in a commercial environment. This equipment generates, uses, and can radiate radio frequency energy and, if not installed and used in accordance with the instruction manual, may cause harmful interference to radio communications. Operation of this equipment in a residential area is likely to cause harmful interference in which case the user will be required to correct the interference at his/her own expense.



**European Community**

**Warning:**

This is a class A product. In a domestic environment this product may cause radio interference in which case the user may be required to take adequate measures.

## UART Commands for Display Control

---

This appendix defines serial data communication protocol and UART commands that engineers can use to program system controls for the MPC-2240 panel computer.

### □ OSD Control Command

- BRI (Brightness Minimum Value)
- BRL (Set LED Brightness of Touch Keypad)
- BRM (Brightness Maximum Value)
- BRT (User Brightness Control)
- BRU (Glass Display Control-Brightness Button)
- BZZ (Buzzer Control)
- DLN (Download ECDIS RGB Package)
- DL? (ECDIS RGB Package Query)
- ETC (Elapsed Time Counter Query)
- GMB (Glass Display Control - Minimum Brightness)
- POT (Potentiometer Control)
- SWI (Scalar Firmware Version Query)
- SWK (Touch Keypad Firmware Version Query)
- ADF (AC Input Power Detect Function)
- AD? (Query AC Input Power Detect Function Status)
- BLI (Brightness Control)
- DUF (Disable UART Command Function)
- EMS (ECDIS Mode Select)

## UART Control Commands

### BRI: Set the Minimum Brightness for the Display Panel

This command sets the minimum brightness value, from 0x00 (0%) to 0x31 (100%). LEN=one byte.

Example :

Command to set 30% brightness.

0x07	0xFF	0x42	0x52	0x49	0x01	0x1B	0x10	0xEF
------	------	------	------	------	------	------	------	------

### BRL: Set the LED Brightness for the Touch Keypad

This command is to set the brightness value for the LED touch keypad. The range starts from 0x00 to 0x31 (0% - 100%). The default brightness value of the touch keypad will be changed in the ratio of the panel backlight brightness. You can send ? to query the current value of the led brightness value. LEN=one byte.

Example :

Command to set 100% Brightness.

0x07	0xFF	0x42	0x52	0x4C	0x01	0x18	0x31	0xCE
------	------	------	------	------	------	------	------	------

### BRM: Set the Maximum Brightness for the Display Panel

This command is to set the maximum brightness value. The range starts from 0x00 (0%) to 0xFF (100%). LEN=one byte.

Example :

Command to set 88% Brightness.

0x07	0xFF	0x42	0x52	0x4D	0x01	0x17	0xE0	0x1F
------	------	------	------	------	------	------	------	------

### BRT: Set the Current Panel Brightness

This command is to set maximum brightness of the panel. The range starts from 0x00 (0%) to 0xFF (100%). The default value is **0xFF**.

Please note whenever the MPC-2240 has been restarted, the BRT value will be reset to 100%. If the BRT value has been changed (the BRT value does not equal to 0xff), the ECDIS function will not be supported and the ECDIS function keys will be disabled and turned off.

If the data and data checksum of sending are incorrect, the data field of replying is the current BRT value.

LEN=one byte.

Example :

Command to set 40% Brightness.

0x07	0xFF	0x42	0x52	0x54	0x01	0x10	0x66	0x99
------	------	------	------	------	------	------	------	------

ACK was set to 40% Brightness

0x06	0xFF	0x42	0x52	0x54	0x01	0x11	0x66	0x99
------	------	------	------	------	------	------	------	------

NAK was default Brightness 100%

0x15	0xFF	0x42	0x52	0x54	0x01	0x02	0xFF	0x00
------	------	------	------	------	------	------	------	------

### BRU: Glass Display Control-Brightness Button

This command is to set led brightness value of the touch keypad. The range starts from 0x00 (0%) to 0xFF (100%). The default brightness value of the touch keypad will be changed in the ratio of the panel backlight brightness.

You can send ? to query the current value of the led brightness value. LEN=one byte.

Example :

Command to set 100% Brightness.

0x07	0xFF	0x42	0x52	0x55	0x01	0x0F	0xFF	0x00
------	------	------	------	------	------	------	------	------

## BZZ: Buzzer Control

Users can send this command to turn the buzzer on or off. The default value is **OFF**.

If the data and data checksum of sending are incorrect, the data field of replying is current buzzer status.

LEN=one byte.

0x00	Turn the buzzer OFF
0xFF	Turn the buzzer ON

Example :

Turn the buzzer **ON**.

0x07	0xFF	0x42	0x5A	0x5A	0x01	0x02	0xFF	0x00
------	------	------	------	------	------	------	------	------

ACK

0x06	0xFF	0x42	0x5A	0x5A	0x01	0x03	0xFF	0x00
------	------	------	------	------	------	------	------	------

## DLN: Download ECDIS RGB Package

This command commands the computer to read the current ECDIS RGB file loaded in the EEPROM and return it via the UART. This command cannot be used on non-ECDIS models. Before using the DLN command, you will need to query the system using the **DL?** command (see below), to see how many packets will be needed to transmit the full file.

To receive the full file over the UART interface will require downloading a series of 32 byte packets. Each packet is numbered, and contains only 30 bytes of data, so a 4k RGB file would be transmitted require a series of 134 packets for complete transmission. Packets must be requested consecutively, by their packet number. To find out how many packets will be required to transmit the full file, use the **DL?** query shown just below.

Every packet is numbered according to its order in the series; this number is contained as a header in byte 7 , with byte 8 encoding an ASCII "-". The 30 bytes that follow are all data, so if the packet is fully loaded the data will be located in bytes 9 to 38.

### Example:

Commands to read packets 0, 1, and 2.

0x07	0xFF	0x44	0x4C	0x4E	0x01	0x1A	0x00	0xFF		
0x07	0xFF	0x44	0x4C	0x4E	0x01	0x1A	0x01	0xFF		
0x07	0xFF	0x44	0x4C	0x4E	0x01	0x1A	0x02	0xFF		

Acknowledgement and transmission of packet 0, the first packet of the RGB file:

0x06	0xFF	0x44	0x4C	0x4E	0x20	0xFC	0x00	-	Data	IDCHK
------	------	------	------	------	------	------	------	---	------	-------

## DL?: ECDIS RGB Package Query

Use this command to determine how many packets will be needed to transmit the full ECDIS RGB file contained in the EEPROM. This command cannot be used on non-ECDIS models. The total number of packets required will equal the size of ECDIS RGB file in bytes divided by 30, so querying a system using a 4k RGB file should require 134 packets to successfully transmit.

Example:

Send **DL?** command to query total number of packets needed to encode the RGB file:

0x07	0xFF	0x44	0x4C	0x3F	0x00	0x2A
------	------	------	------	------	------	------

The system acknowledges, and returns an answer of 255 packets:

0x06	0xFF	0x44	0x4C	0x3F	0x01	0x2A	0xFF	0x00
------	------	------	------	------	------	------	------	------

## ETC: Elapsed Time Counter Query

This command returns the elapsed time since the MPC-2240 was last booted up. The MCP-2240 will reply to this command with an ACK packet. The largest byte will be transmitted first.

The maximum indicator for this function is 99999 hours (defined into 5 bytes, numbers 0 to 9 each), equivalent to 11 years. If this number is reached, the ETC will stop counting, and the ETC command will always reply with maximum number of hours (99999).

Example:

Send **ETC** to query elapsed time:

0x07	0xFF	0x45	0x54	0x43	0x00	0x1D
------	------	------	------	------	------	------

ACK 99999 hours

06	FF	45	54	43	05	19	39	39	39	39	39	E2
----	----	----	----	----	----	----	----	----	----	----	----	----

## GMB: Glass Display Control - Minimum Brightness

This command is to set the minimum value limit for the brightness of touch keypad LED to make sure that the LED indicators are still visible if they was previously adjusted down to a very low value. The range starts from 0x00 to 0x31 (0% - 100%). LEN=one byte.

Example :

Command to set 30% Brightness.

0x07	0xFF	0x47	0x4D	0x42	0x01	0x22	0x10	0xEF
------	------	------	------	------	------	------	------	------

## POT: Potentiometer Control

This command enables or disables the brightness keys (+/-). If the data and data checksum do not match, the computer will return a NACK packet, and indicate the current control status in the data field (byte 8). LEN=one byte.

0x00	Brightness +/Brightness - Key Disable
0xFF	Brightness +/Brightness - Key Enable

Example :

Disable the BR+/BR- Key.

0x07	0xFF	0x50	0x4F	0x54	0x01	0x05	0x00	0xFF
------	------	------	------	------	------	------	------	------

ACK

0x06	0xFF	0x50	0x4F	0x54	0x01	0x06	0x00	0xFF
------	------	------	------	------	------	------	------	------

## SWI: Query the Scalar Board's Firmware Version

This command returns the version of the scalar board's firmware.

Example:

Query the Scalar Board's Firmware Version

0x07	0xFF	0x53	0x57	0x49	0x00	0x06
------	------	------	------	------	------	------

## SWK: Touch Keypad Firmware Version Query

This command returns the firmware version for the SavvyTouch display controls.

Example:

Query SavvyTouchFirmware Version

0x07	0xFF	0x53	0x57	0x4B	0x00	0x04
------	------	------	------	------	------	------

## ADF: AC Input Power Detect Function

This default value of this function is **OFF**. If the MPC-2240 supports AC power input, users can turn on this function to detect AC input power when the MPC-2240 has connected to the AC power. LEN=one byte.

0x00	AC Input Power Detect is OFF
0xFF	AC Input Power Detect is ON

Example :

Set "OFF".

0x07	0xFF	0x41	0x44	0x46	0x01	0x2D	0x00	0xFF
------	------	------	------	------	------	------	------	------

ACK

0x06	0xFF	0x41	0x44	0x46	0x01	0x2E	0x00	0xFF
------	------	------	------	------	------	------	------	------

## AD?: Query AC Input Power Detect Function Status

If the MPC-2240 supports AC power input, users can use command is to query AC Input Power Detect Function Status.

0x00	AC Input Power Detect is OFF
0xFF	AC Input Power Detect is ON

Example :

Send **AD?** command to Query AC Input Power Detect Function Status

0x07	0xFF	0x41	0x44	0x3F	0x00	0x35
------	------	------	------	------	------	------

ACK

0x06	0xFF	0x41	0x44	0x3F	0x01	0x35	0x00	0xFF
------	------	------	------	------	------	------	------	------

## BLI: Brightness Control

This command is to set the panel brightness. Brightness range is from 0x00 to 0xFF. Default Brightness is 160. LEN=one byte.

Example :

Set brightness to 255(0xFF)

0x07	0xFF	0x42	0x4C	0x49	0x01	0x21	0xFF	0x00
------	------	------	------	------	------	------	------	------

ACK

0x06	0xFF	0x42	0x4C	0x49	0x01	0x22	0xFF	0x00
------	------	------	------	------	------	------	------	------

Query current brightness value

0x07	0xFF	0x42	0x4C	0x49	0x00	0x22
------	------	------	------	------	------	------

ACK

0x06	0xFF	0x42	0x4C	0x49	0x01	0x22	0xFF	0x00
------	------	------	------	------	------	------	------	------

## DUF: Disable UART Command Function

Users can use this command to disable related command control. LEN=one byte.

DATA	IDCHK	Function description
0x00	0xFF	Disable all command control
0x01	0xFE	Disable BRI control
0x02	0xFD	Disable BRL control
0x04	0xFB	Disable BRM setting, returning the controls to factory default
0x08	0xF7	Disable BZZ control
0x10	0xEF	Disable ETC control
0x20	0xDF	Disable GMB control
0x40	0xBF	Disable POT control

Example :

Disable all command control

0x07	0xFF	0x44	0x55	0x46	0x01	0x19	0x00	0xFF
------	------	------	------	------	------	------	------	------

ACK

0x06	0xFF	0x44	0x55	0x46	0x01	0x1A	0x00	0xFF
------	------	------	------	------	------	------	------	------

NACK

0x15	0xFF	0x44	0x55	0x46	0x01	0x0B	0x00	0xFF
------	------	------	------	------	------	------	------	------

## EMS: ECDIS Mode Select

For the ECDIS models, users can use this command to switch DAY, DUSK and NIGHT mode. LEN=one byte.

	DATA	IDCHK
DAY	0x00	0xFF
DUSK	0x01	0xFE
NIGHT	0x02	0xFD

Example :

Switch to DUSK mode

0x07	0xFF	0x45	0x4D	0x53	0x01	0x13	0x01	0xFE
------	------	------	------	------	------	------	------	------

ACK

0x06	0xFF	0x45	0x4D	0x53	0x01	0x14	0x01	0xFE
------	------	------	------	------	------	------	------	------

NACK

0x15	0xFF	0x45	0x4D	0x53	0x01	0x0B	0x01	0xFE
------	------	------	------	------	------	------	------	------