

# DrayTek

## Vigor2862 Series

VDSL2 Security Firewall



Quick Start Guide (RF Model)

V1.3

# Vigor2862 Series VDSL2 Security Firewall Quick Start Guide (for RF Model)

Version: 1.3

Firmware Version: V3.8.8

(For future update, please visit [DrayTek web site](#))

Date: March 6, 2018

## Intellectual Property Rights (IPR) Information

### Copyrights

© All rights reserved. This publication contains information that is protected by copyright. No part may be reproduced, transmitted, transcribed, stored in a retrieval system, or translated into any language without written permission from the copyright holders.

### Trademarks

The following trademarks are used in this document:

- Microsoft is a registered trademark of Microsoft Corp.
- Windows, Windows 95, 98, Me, NT, 2000, XP, Vista, 7, 8 and Explorer are trademarks of Microsoft Corp.
- Apple and Mac OS are registered trademarks of Apple Inc.
- Other products may be trademarks or registered trademarks of their respective manufacturers.

## Safety Instructions and Approval

### Safety

#### Instructions

- Read the installation guide thoroughly before you set up the router.
- The router is a complicated electronic unit that may be repaired only by authorized and qualified personnel. Do not try to open or repair the router yourself.
- Do not place the router in a damp or humid place, e.g. a bathroom.
- Do not stack the routers.
- The router should be used in a sheltered area, within a temperature range of +5 to +40 Celsius.
- Do not expose the router to direct sunlight or other heat sources. The housing and electronic components may be damaged by direct sunlight or heat sources.
- Do not deploy the cable for LAN connection outdoor to prevent electronic shock hazards.
- Keep the package out of reach of children.
- When you want to dispose of the router, please follow local regulations on conservation of the environment.

### Warranty

We warrant to the original end user (purchaser) that the router will be free from any defects in workmanship or materials for a period of two (2) years from the date of purchase from the dealer. Please keep your purchase receipt in a safe place as it serves as proof of date of purchase. During the warranty period, and upon proof of purchase, should the product have indications of failure due to faulty workmanship and/or materials, we will, at our discretion, repair or replace the defective products or components, without charge for either parts or labor, to whatever extent we deem necessary to restore the product to proper operating condition. Any replacement will consist of a new or re-manufactured functionally equivalent product of equal value, and will be offered solely at our discretion. This warranty will not apply if the product is modified, misused, tampered with, damaged by an act of God, or subjected to abnormal working conditions. The warranty does not cover the bundled or licensed software of other vendors. Defects which do not significantly affect the usability of the product will not be covered by the warranty. We reserve the right to revise the manual and online documentation and to make changes from time to time in the contents hereof without obligation to notify any person of such revision or changes.



## Declaration of Conformity

Hereby, DrayTek Corporation declares that the radio equipment type Vigor2862 is in compliance with Directive 2014/53/EU.

The full text of the EU Declaration of Conformity is available at the following internet address:

<http://www.draytek.com.tw/ftp/Vigor2862/Document/CE/>

Manufacturer: DrayTek Corp.

Address: No. 26, Fu Shing Road, HuKou Township, HsinChu Industrial Park, Hsin-Chu County, Taiwan 303

Product: Vigor2862 Series

Frequency Information for Europe area:

2.4G WLAN	2412MHz - 2472 MHz, max. TX power: 19.98dBm *1
5G WLAN	5180MHz - 5700 MHz, max. TX power: 27.00dBm *2
LTE	B1[1920-1980 MHz (TX); 2110-2170 MHz (RX)]; B3[1710-1785 MHz (TX); 1805-1880 MHz (RX)]; B7[2500-2570 MHz (TX); 2620-2690 MHz (RX)]; B8[880-915 MHz (TX); 925-960 MHz (RX)]; B20[832-862 MHz (TX); 791-821 MHz (RX)]; *3
3G	B1[1920-1980 MHz (TX); 2110-2170 MHz (RX)]; B8[880-915 MHz (TX); 925-960 MHz (RX)] *3
2G	900[880-915 MHz (TX); 925-960 MHz (RX)]; 1900[1710-1785 MHz (TX); 1805-1880 MHz (RX)] *3
	Requirements in AT/BE/BG/CZ/DZ/DK/EE/FR/DE/IS/IE/IT/EL/ES/CY/LV/LI/LT/LU/HU/MT/NL/NO/PL/PT/RO/SI/SK/TR/FI/SE/CH/UK/HR. 5150MHz~5350MHz is for indoor use only.

(\*1: for 2.4G WLAN model; \*2: for 5G WLAN model; \*3: for LTE model)

This product is designed for LTE, POTS, DSL and 2.4GHz /5GHz WLAN network throughout the EC region.



## Regulatory Information

### Federal Communication Commission Interference Statement

This equipment has been tested and found to comply with the limits for a Class B digital device, pursuant to Part 15 of the FCC Rules. These limits are designed to provide reasonable protection against harmful interference in a residential installation. This equipment generates, uses and can radiate radio frequency energy and, if not installed and used in accordance with the instructions, may cause harmful interference to radio communications. However, there is no guarantee that interference will not occur in a particular installation. If this equipment does cause harmful interference to radio or television reception, which can be determined by turning the equipment off and on, the user is encouraged to try to correct the interference by one of the following measures:

- Reorient or relocate the receiving antenna.
- Increase the separation between the equipment and receiver.
- Connect the equipment into an outlet on a circuit different from that to which the receiver is connected.
- Consult the dealer or an experienced radio/TV technician for help.

This device complies with Part 15 of the FCC Rules. Operation is subject to the following two conditions:

- (1) This device may not cause harmful interference, and
- (2) This device may accept any interference received, including interference that may cause undesired operation.

Caution: Any changes or modifications not expressly approved by the party responsible for compliance could void the user's authority to operate the equipment.

The antenna/transmitter should be kept at least 20 cm away from human body.

DrayTek Vigor2862 series VDSL2/ADSL2+ routers are compliant with 47 C.F.R. Part 68.



More update, please visit [www.draytek.com](http://www.draytek.com).

## Be a Registered Owner

Web registration is preferred. You can register your Vigor router via <http://www.draytek.com>.

## Firmware & Tools Updates

Due to the continuous evolution of DrayTek technology, all routers will be regularly upgraded. Please consult the DrayTek web site for more information on newest firmware, tools and documents. <http://www.draytek.com>

## ***Table of Contents***

<b>1. Introduction.....</b>	<b>1</b>
<b>2. Package Content .....</b>	<b>2</b>
<b>3. Panel Explanation.....</b>	<b>3</b>
3.1 Vigor2862L .....	3
3.2 Vigor2862n / Vigor2862ac / Vigor2862Bn / Vigor2862Ln / Vigor2862Lac.....	5
3.3 Vigor2862Vac .....	9
3.4 Notes for Antenna Installation (for “L” model) .....	11
3.5 Notes for Y Cable Application.....	13
<b>4. Hardware Installation .....</b>	<b>14</b>
4.1 Network Connection .....	14
4.2 Wall-Mounted Installation .....	15
<b>5. Software Configuration .....</b>	<b>16</b>
5.1 Quick Start Wizard for Network Connection.....	16
<b>6. Customer Service .....</b>	<b>22</b>

# 1. Introduction

Vigor2862 series is a VDSL2 router with multi-subnet for secure and efficient workgroup management. It integrates IP layer QoS, NAT session/bandwidth management to help users control works well with large bandwidth.

By adopting hardware-based VPN platform and hardware encryption of AES/DES/3DES, and hardware key hash of SHA-1/MD5, the router increases the performance of VPN greatly and offers several protocols (such as IPSec/PPTP/L2TP) with up to 32 VPN tunnels.

The object-based design used in SPI (Stateful Packet Inspection) firewall allows users to set firewall policy with ease. CSM (Content Security Management) provides users control and management in IM (Instant Messenger) and P2P (Peer to Peer) more efficiency than before. In addition, DoS/DDoS prevention and URL/Web content filter strengthen the security outside and control inside.

Vigor2862 series supports USB interface for connecting USB printer to share printing function, 3G/4G USB modem for network connection, connectivity for network FTP service, or thermometer for monitoring the temperature change.

Vigor2862 "B" series can enhance the transmission rate and enlarge the bandwidth by combining two standard VDSL2 lines, thus it is able to provide low line prices instead of expensive leased lines. Meanwhile, the speed of existing connection established for customers can be increased.

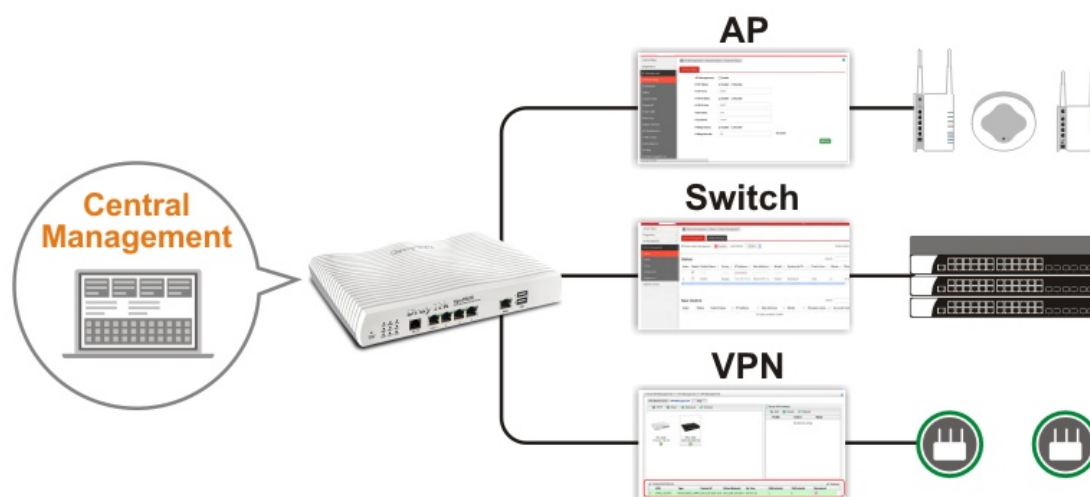



## 2. Package Content

Take a look at the package content. If there is anything missed or damaged, please contact DrayTek or dealer immediately.



**Vigor Router & Quick Start Guide**

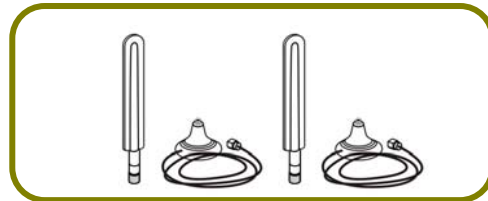

**Antenna + Socket (L models)**

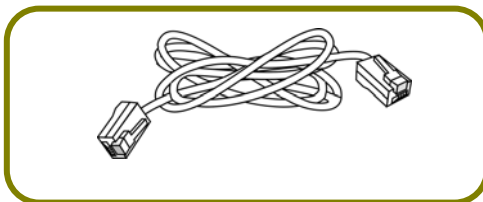

**RJ-45 to RJ-45 Cable  
(Annex B)**



**RJ-11 to RJ-45 Cable (Annex B)  
RJ-11 to RJ-11 Cable (Annex A)**

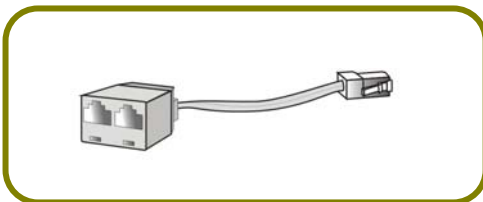

**Y Cable (B models)**

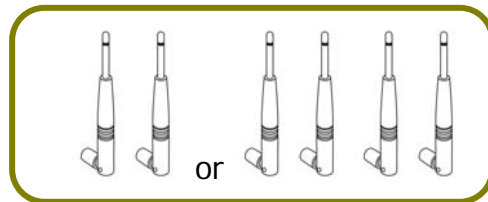

**Antenna (n or ac models)**

The type of the power adapter depends on the country that the router will be installed. \* The maximum power consumption is *30 Watt*.

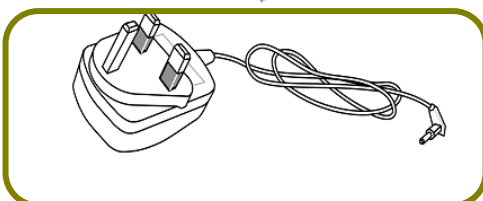

**UK-type Power Adapter**

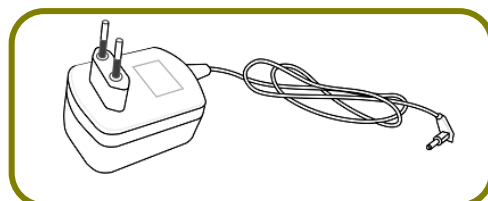

**EU-type Power Adapter**

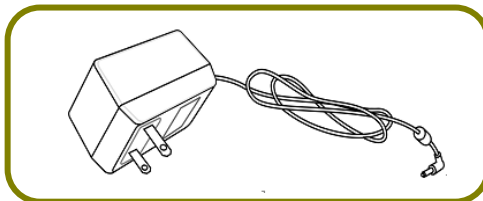

**USA/Taiwan-type Power Adapter**

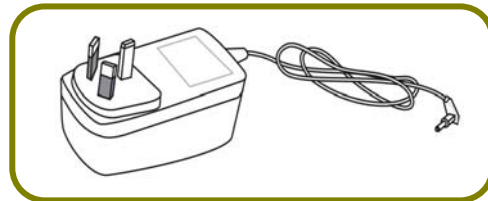

**AU/NZ-type Power Adapter**

### 3. Panel Explanation

#### 3.1 Vigor2862L

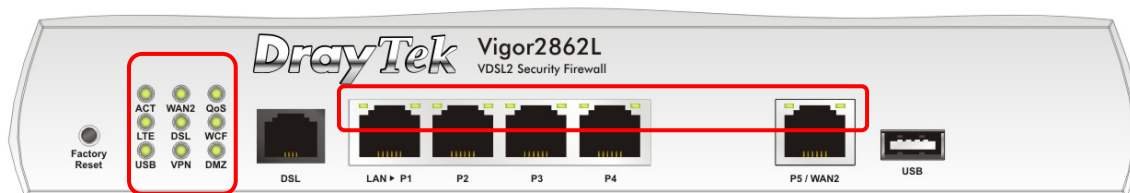

LED	Status	Explanation	
ACT (Activity)	Off	The router is powered off.	
	Blinking	The router is powered on and running normally.	
WAN2	On	Internet connection is ready.	
	Off	Internet connection is not ready.	
	Blinking	The data is transmitting.	
QoS	On	The QoS function is active.	
	Off	The QoS function is inactive.	
LTE	On	LTE device is connected and ready for use.	
	Off	LTE device is not detected, or has serious problem (e.g., no SIM card, SIM pin error, SIM deactivated, and etc.).	
	Blinking	Slowly: LTE device is in dialing up. Quickly: The data is transmitting.	
DSL	On	The router is ready to access Internet through DSL link.	
	Blinking	Slowly: The DSL connection is ready. Quickly: The connection is training.	
WCF	On	The Web Content Filter is active. (It is enabled from <b>Firewall &gt;&gt; General Setup</b> ).	
	Off	WCF is disabled.	
USB	On	USB device is connected and ready for use.	
	Off	No USB device is connected.	
	Blinking	The data is transmitting.	
VPN	On	The VPN tunnel is active.	
	Off	VPN services are disabled	
	Blinking	Traffic is passing through VPN tunnel.	
DMZ	On	The DMZ function is enabled.	
	Off	The DMZ function is disabled.	
	Blinking	The data is transmitting.	
<b>LED on Connector</b>			
LAN P1-P4	Left LED	On	The port is connected.
		Off	The port is disconnected.
		Blinking	The data is transmitting.

P5/ WAN2	Right LED	On	The port is connected with 1000Mbps.
		Off	The port is connected with 10/100Mbps
	Left LED	On	The port is connected.
		Off	The port is disconnected.
		Blinking	The data is transmitting.
	Right LED	On	The port is connected with 1000Mbps.
Off		The port is connected with 10/100Mbps	

The port "P5 / WAN2" is switchable. It can be used for LAN connection or WAN connection according to the settings configured in WUI.

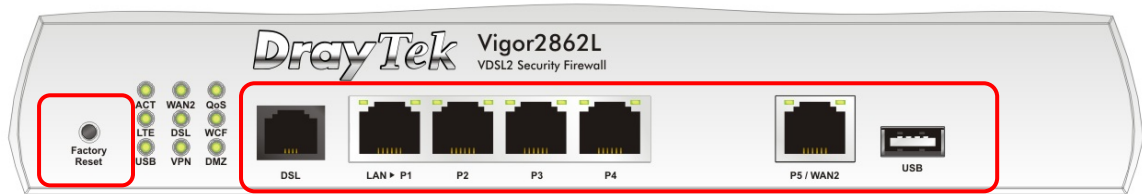

Switch on Rear Side



(Jack for LTE device)

Interface	Description
Factory Reset	Restore the default settings. Usage: Turn on the router (ACT LED is blinking). Press the hole and keep for more than 5 seconds. When you see the ACT LED begins to blink rapidly than usual, release the button. Then the router will restart with the factory default configuration.
DSL / DSL 1/2	Connector for accessing the Internet.
LAN P1-P4	Connectors for local network devices.
P5/WAN2	Connector for local network devices or modem for accessing Internet.
USB	Connector for a USB device (for 3G/4G USB Modem or printer or thermometer).
PWR	Connector for a power adapter.
ON/OFF	Power Switch.

### 3.2 Vigor2862n / Vigor2862ac / Vigor2862Bn / Vigor2862Ln / Vigor2862Lac

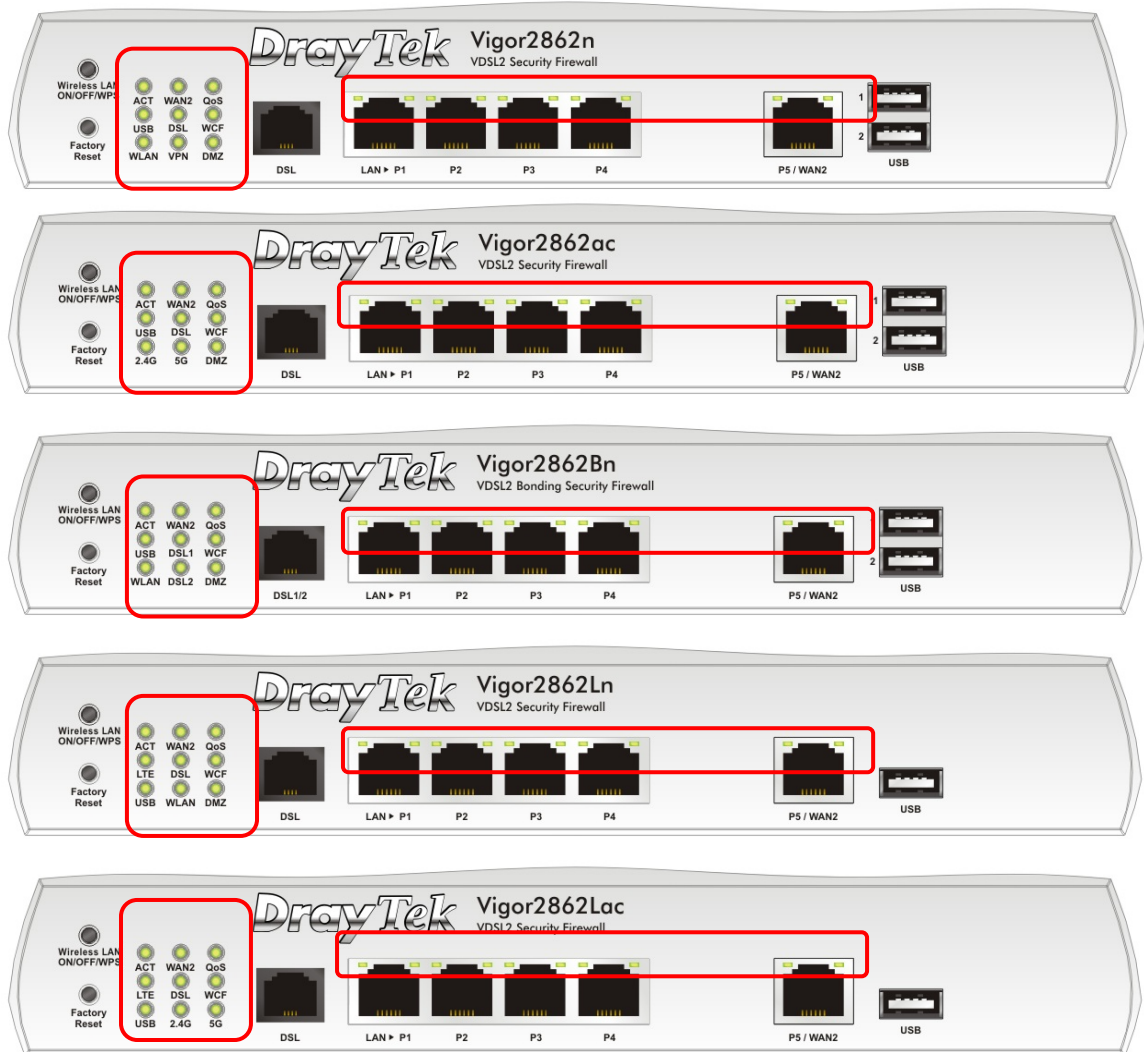

LED	Status	Explanation
ACT (Activity)	Off	The router is powered off.
	Blinking	The router is powered on and running normally.
WAN2	On	Internet connection is ready.
	Off	Internet connection is not ready.
	Blinking	The data is transmitting.
QoS	On	The QoS function is active.
	Off	The QoS function is inactive.
LTE	On	LTE device is connected and ready for use.
	Off	LTE device is not detected, or has serious problem (e.g., no SIM card, SIM pin error, SIM deactivated, and etc.).
	Blinking	Slowly: LTE device is in dialing up. Quickly: The data is transmitting.

DSL / DSL 1/2	On	The router is ready to access Internet through DSL link.
	Blinking	Slowly: The DSL connection is ready. Quickly: The connection is training.
WCF	On	The Web Content Filter is active. (It is enabled from <b>Firewall &gt;&gt; General Setup</b> ).
	Off	WCF is disabled.
USB	On	USB device is connected and ready for use.
	Off	No USB device is connected.
	Blinking	The data is transmitting.
2.4G/5G/WLAN	On	2.4G/5G: Wireless access point with bandwidth of 2.4GHz/5GHz is ready. WLAN: Wireless access point is ready.
	Off	Wireless function is disabled.
	Blinking	It will blink slowly while wireless traffic goes through. ACT and WLAN LEDs blink quickly and simultaneously when WPS is working, and will return to normal condition after two minutes. (You need to setup WPS within 2 minutes.)
VPN	On	The VPN tunnel is active.
	Off	VPN services are disabled
	Blinking	Traffic is passing through VPN tunnel.
DMZ	On	The DMZ function is enabled.
	Off	The DMZ function is disabled.
	Blinking	The data is transmitting.

***LED on Connector***

LAN P1~P4	Left LED	On	The port is connected.
		Off	The port is disconnected.
		Blinking	The data is transmitting.
	Right LED	On	The port is connected with 1000Mbps.
		Off	The port is connected with 10/100Mbps
P5/ WAN2	Left LED	On	The port is connected.
		Off	The port is disconnected.
		Blinking	The data is transmitting.
	Right LED	On	The port is connected with 1000Mbps.
		Off	The port is connected with 10/100Mbps

The port "P5 / WAN2" is switchable. It can be used for LAN connection or WAN connection according to the settings configured in WUI.

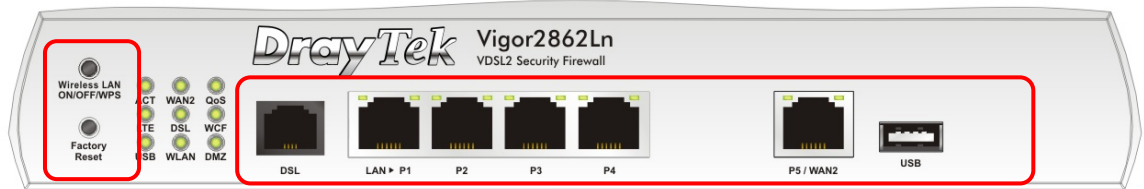
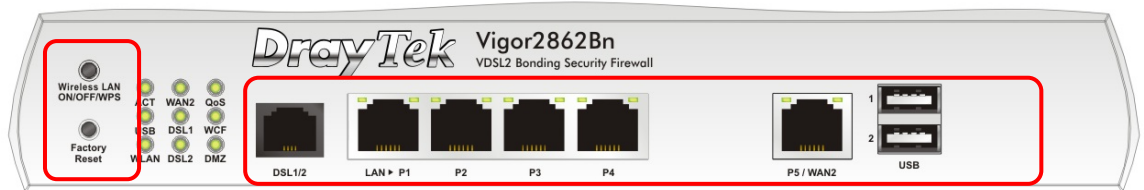
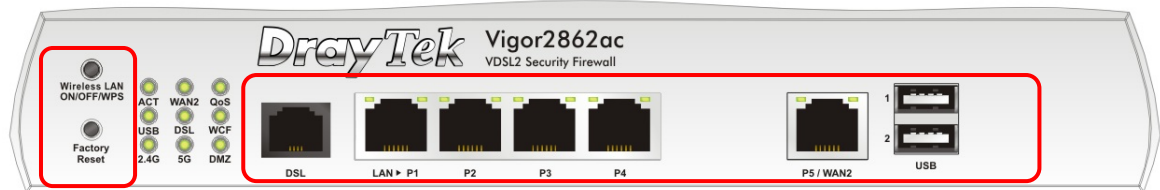
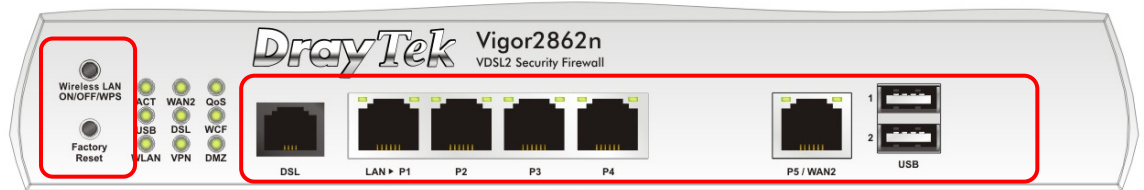

Switch on Rear Side



(Available for Vigor2862Ln/Lac)

Interface	Description
Wireless LAN ON/OFF/WPS	<p>For Vigor2862n /Vigor2862Bn:</p> <ul style="list-style-type: none"> <li>● Press the button and release it within 2 seconds. When the wireless function is ready, the green LED will be on.</li> <li>● Press the button and release it within 2 seconds to turn off the WLAN function. When the wireless function is not ready, the LED will be off.</li> </ul> <p>For Vigor2862ac/Vigor2862Ln/Vigor2862Lac: Wireless band will be switched /changed according to the button pressed and released. For example,</p> <ul style="list-style-type: none"> <li>● 2.4G (On) and 5G (On) - in default.</li> <li>● 2.4G (Off) and 5G (On) - pressed and released the button once.</li> <li>● 2.4G (On) and 5G (Off) - pressed and released the button</li> </ul>

	<p>twice.</p> <ul style="list-style-type: none"> <li>● 2.4G (Off) and 5G (Off) - pressed and released the button three times.</li> </ul> <p>When WPS function is enabled by web user interface, press this button for more than 2 seconds to wait for client's device making network connection through WPS.</p>
Factory Reset	Restore the default settings. Usage: Turn on the router (ACT LED is blinking). Press the hole and keep for more than 5 seconds. When you see the ACT LED begins to blink rapidly than usual, release the button. Then the router will restart with the factory default configuration.
USB1~2	Connector for a USB device (for 3G/4G USB Modem or printer or thermometer).
DSL / DSL 1/2	Connector for accessing the Internet.
LAN P1-P4	Connectors for local network devices.
P5 / WAN2	Connector for local network devices or modem for accessing Internet.
PWR	Connector for a power adapter.
ON/OFF	Power Switch.

### 3.3 Vigor2862Vac

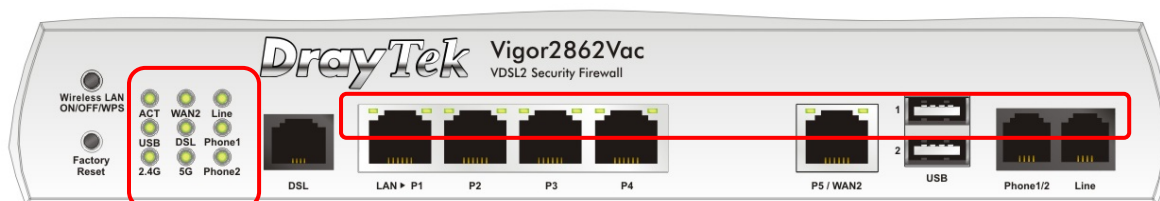

LED	Status	Explanation
ACT (Activity)	Blinking	The router is powered on and running normally.
	Off	The router is powered off.
USB	On	USB device is connected and ready for use.
	Blinking	The data is transmitting.
WAN2	On	Internet connection is ready.
	Off	Internet connection is not ready.
	Blinking	The data is transmitting.
DSL	On	The router is ready to access Internet through DSL link.
	Blinking	Slowly: The DSL connection is ready. Quickly: The connection is training.
2.4G/5G	On	2.4G/5G: Wireless access point with bandwidth of 2.4GHz/5GHz is ready. WLAN: Wireless access point is ready.
	Blinking	It will blink slowly while wireless traffic goes through. ACT and WLAN LEDs blink quickly and simultaneously when WPS is working, and will return to normal condition after two minutes. (You need to setup WPS within 2 minutes.)
Line	On	A PSTN phone call comes (in and out). However, when the phone call is disconnected, the LED will be off.
	Off	There is no PSTN phone call.
Phone 1/2	On	The phone connected to this port is off-hook.
	Off	The phone connected to this port is on-hook.
	Blinking	A phone call comes.

#### LED on Connector

LAN P1-P4	Left LED (Green)	On	The port is connected.
		Off	The port is disconnected.
		Blinking	The data is transmitting.
LAN P1-P4	Right LED (Green)	On	The port is connected with 1000Mbps.
		Off	The port is connected with 10/100Mbps.
P5/ WAN2	Left LED (Green)	On	The port is connected.
		Off	The port is disconnected.
		Blinking	The data is transmitting.
P5/ WAN2	Right LED (Green)	On	The port is connected with 1000Mbps.
		Off	The port is connected with 10/100Mbps.

The port "P5 / WAN2" is switchable. It can be used for LAN connection or WAN connection according to the settings configured in WUI.



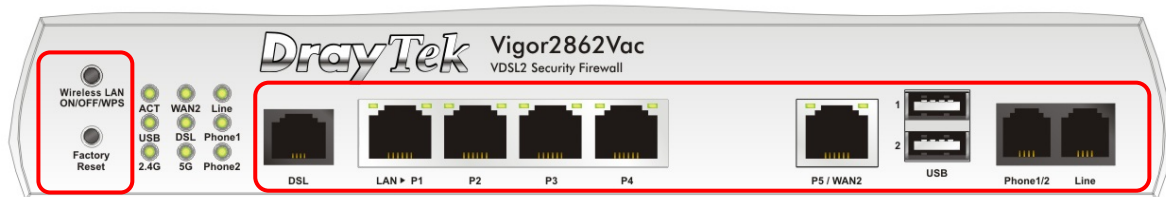

Interface	Description
Wireless LAN ON/OFF/WPS	<p>Wireless band will be switched /changed according to the button pressed and released. For example,</p> <ul style="list-style-type: none"> <li>● 2.4G (On) and 5G (On) - in default.</li> <li>● 2.4G (Off) and 5G (On) - pressed and released the button once.</li> <li>● 2.4G (On) and 5G (Off) - pressed and released the button twice.</li> <li>● 2.4G (Off) and 5G (Off) - pressed and released the button three times.</li> </ul> <p>When WPS function is enabled by web user interface, press this button for more than 2 seconds to wait for client's device making network connection through WPS.</p>
Factory Reset	Restore the default settings. Usage: Turn on the router (ACT LED is blinking). Press the hole and keep for more than 5 seconds. When you see the ACT LED begins to blink rapidly than usual, release the button. Then the router will restart with the factory default configuration.
DSL	Connector for accessing the Internet.
LAN P1~ P4	Connecters for local network devices.
P5 / WAN2	Connector for local network devices or modem for accessing Internet.
USB1~USB2	Connector for a USB device (for 3G/4G USB Modem or printer or Environmental Thermometer).
Phone 1/2	Connector for analog phone(s).
Line	Connector for PSTN life line.
PWR	Connector for a power adapter.
ON/OFF	Power Switch.

### 3.4 Notes for Antenna Installation (for "L" model)

Magnetic antenna must be installed on the extension base before connecting to Vigor router.

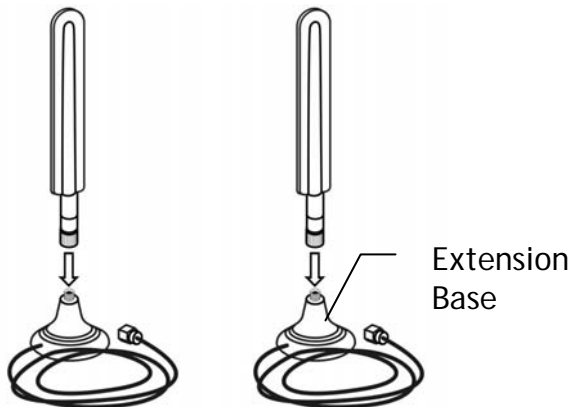

There are two mounting holes for installing antennas with extension base on Vigor router. Please install them as shown below.

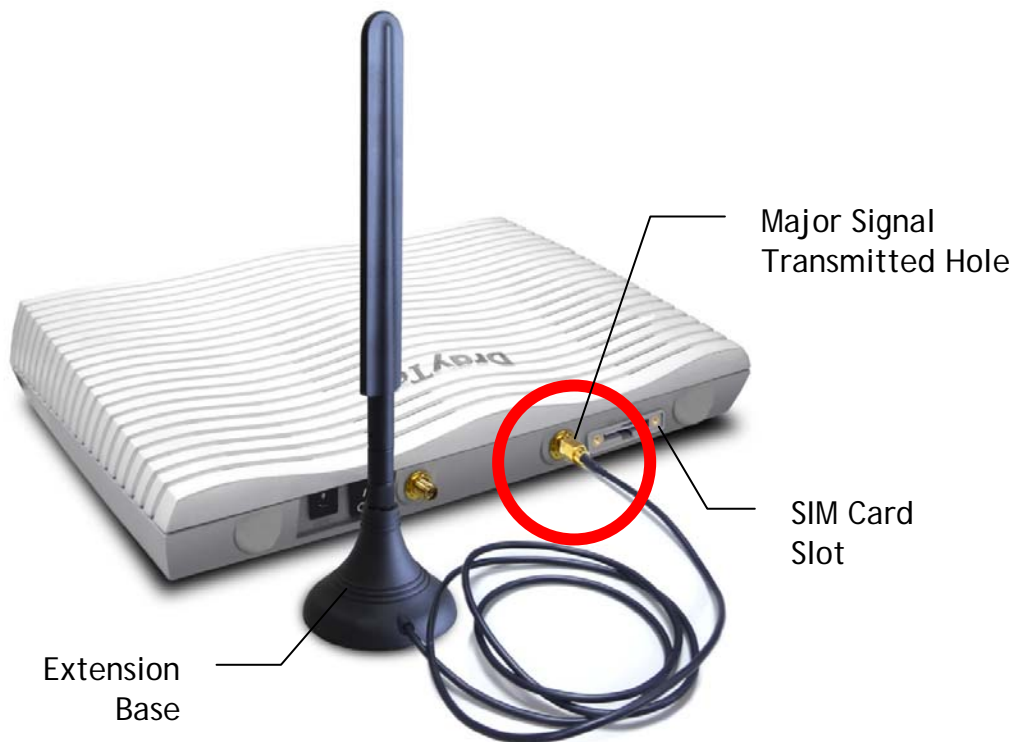

Note, if only one antenna shall be installed, please use the mounting hole (major signal transmitted hole) near to the SIM card slot.

While installing the SIM card into the card slot, note that back plate of the SIM card slot must be removed first and the direction of card notch must be on the left side.



There are two types of antennas provided for Vigor2862Ln/Vigor2862Lac, which must be installed in different locations carefully and correctly. Wrong installation might cause bad signal of wireless connection. Therefore, pay attention to the installation of antennas by referring to the following illustration.

SMA jack for LTE Antenna  
(with extension base)

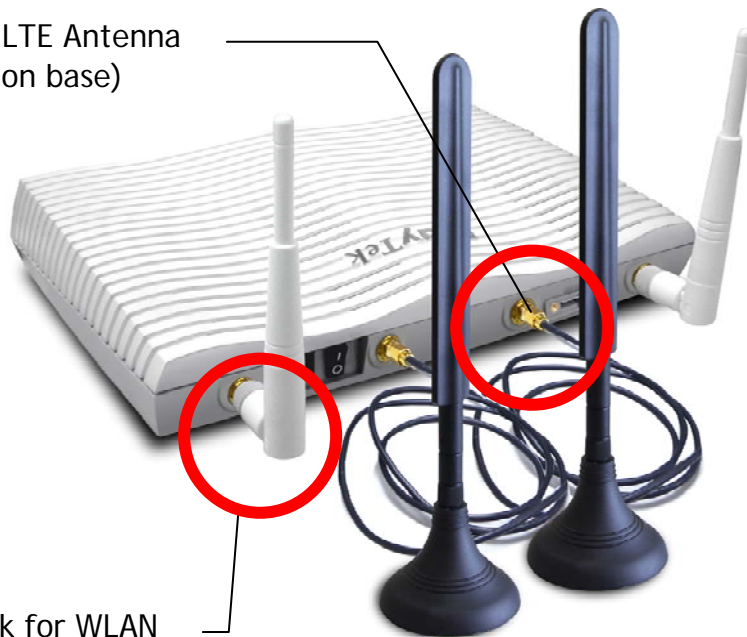

SMA jack for WLAN  
Antenna

### 3.5 Notes for Y Cable Application

Y cable is prepared for the one who applies bonding VDSL service (two lines or one line) to ISP for enhancing the transmission rate and enlarging the bandwidth.

However, the following conditions shall be considered first while installing the DSL line(s) on to Vigor router.

**Condition 1:** When the bonding VDSL service offered by ISP contains two separate cables, please insert the Y cable to the DSL1/2 connector of Vigor router first. Then, connect the two VDSL cables to dual-connector marked with 1 and 2 on Y cable.

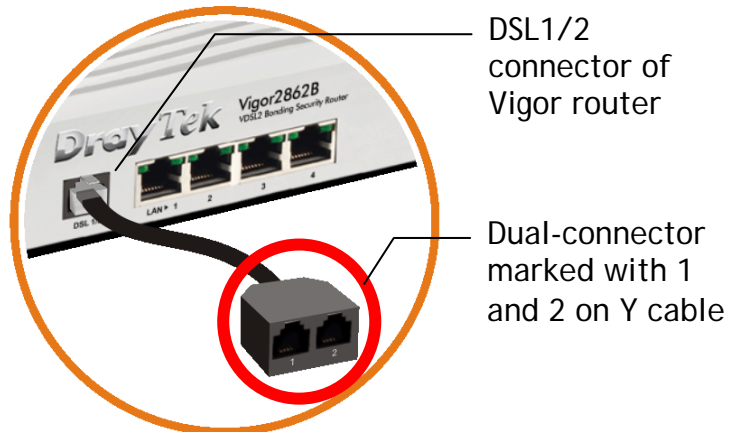

**Condition 2:** When the bonding VDSL service offered by ISP contains only one cable (contains two VDSL lines), simply connect it to the DSL1/2 connector of Vigor router.



**Condition 3:** However, when the user purchased bonding VDSL router (e.g., B models) but did not apply for bonding VDSL service from local ISP, the Y cable should be inserted to the DSL1/2 connector of Vigor router first. Later, connect the VDSL cable (contains one VDSL line) to the dual-connector marked with 1 to reduce the unnecessary signal interference and reduce the time of signal detection.

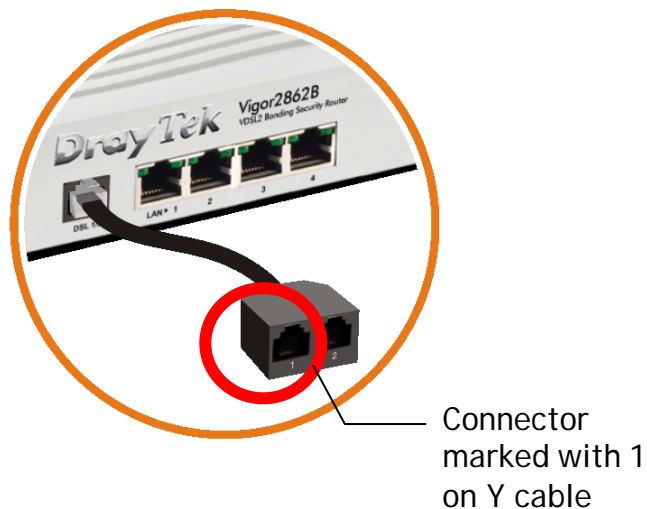

## 4. Hardware Installation

This section will guide you to install the router through hardware connection and configure the router's settings through web browser.

Before starting to configure the router, you have to connect your devices correctly. (For the hardware connection, we take "ac" model as an example.)

### 4.1 Network Connection

1. Connect the DSL interface to the land line jack with a DSL line cable, or Connect the cable Modem/DSL Modem/Media Converter to the WAN port of router with Ethernet cable (RJ-45).
2. Connect one end of an Ethernet cable (RJ-45) to one of the LAN ports of the router and the other end of the cable (RJ-45) into the Ethernet port on your computer.
3. Connect one end of the power adapter to the router's power port on the rear panel, and the other side into a wall outlet.
4. Power on the device by pressing down the power switch on the rear panel.
5. The system starts to initiate. After completing the system test, the **ACT** LED will light up and start blinking. (For the detailed information of LED status, please refer to section 3. Panel Explanation)

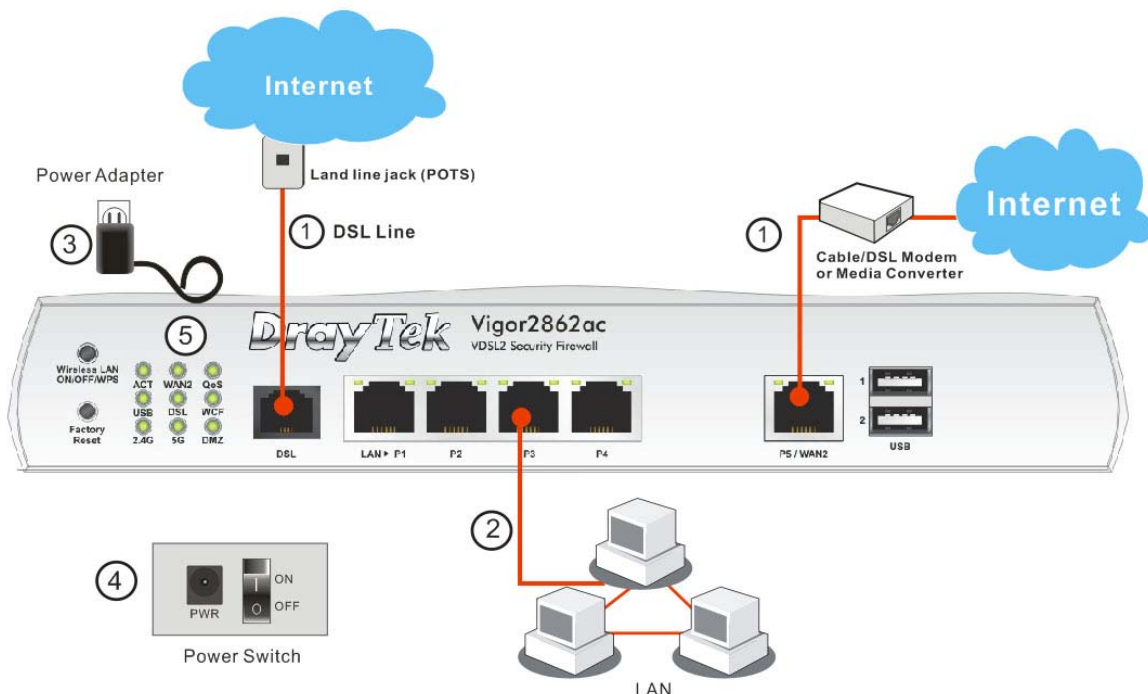

## 4.2 Wall-Mounted Installation

Vigor router has keyhole type mounting slots on the underside.

1. A template is provided on the Vigor router packaging box to enable you to space the screws correctly on the wall.
2. Place the template on the wall and drill the holes according to the recommended instruction.
3. Fit screws into the wall using the appropriate type of wall plug.

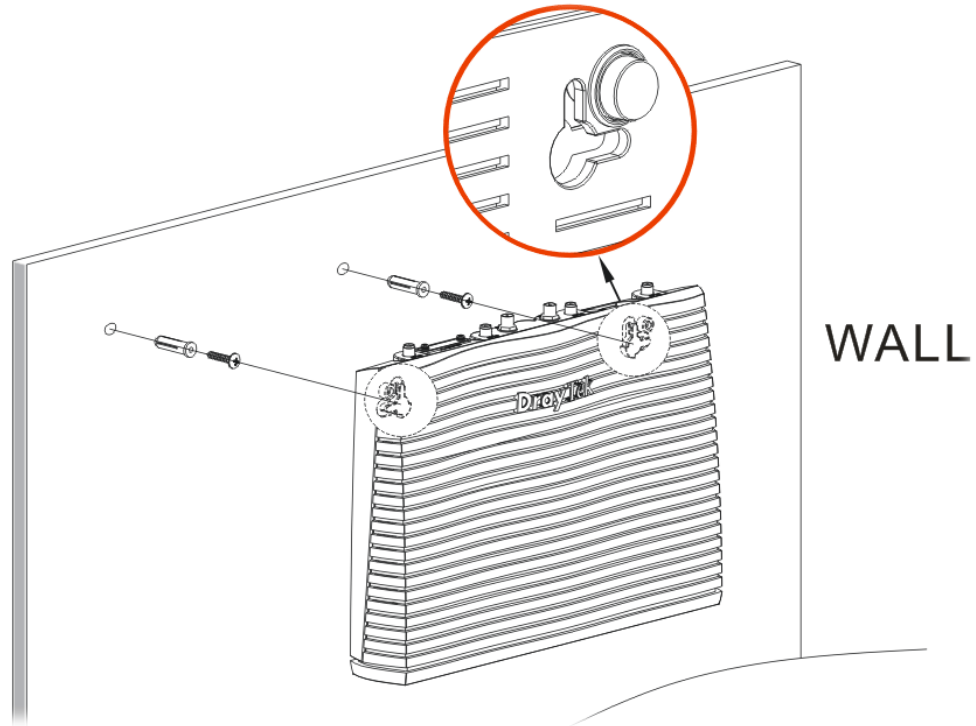

**Note**

The recommended drill diameter shall be 6.5mm (1/4").

4. When you finished about procedure, the router has been mounted on the wall firmly.

## 5. Software Configuration

To access Internet, please finish basic configuration after completing the hardware installation.

### 5.1 Quick Start Wizard for Network Connection

The **Quick Start Wizard** is designed for you to easily set up your router for Internet access. You can directly access the **Quick Start Wizard** via Web Configurator. Make sure your PC connects to the router correctly.



---

#### Note

You may either simply set up your computer to get IP dynamically from the router or set up the IP address of the computer to be the same subnet as the **default IP address of Vigor router 192.168.1.1**. For the detailed information, please refer to - Trouble Shooting of the user's guide.

---

Open a web browser on your PC and type **http://192.168.1.1**. A pop-up window will open to ask for username and password. Please type "admin/admin" as the Username/Password and click **Login**.



---

#### Note

If you fail to access to the web configuration, please go to "Trouble Shooting" on User's Guide for detecting and solving your problem.

---

Now, the Main Screen will pop up. Click Wizards>>Quick Start Wizard.

**System Information**

Model Name	Vigor2862Vac	System Up Time	0:00:39
Router Name	DrayTek	Current Time	2000 Jan 1 Sat 0:0:33
Firmware Version	3.8.8	Build Date/Time	May 18 2017 03:05:00
DSL Version	07-07-06-0D-00-07	LAN MAC Address	00-1D-AA-F7-C0-FD

**IPv4 LAN Information**

	IP Address	DHCP		IP Address	DHCP
LAN1	192.168.1.1/24	v	LAN2	192.168.2.1/24	v
LAN3	192.168.3.1/24	v	LAN4	192.168.4.1/24	v
LAN5	192.168.5.1/24	v	LAN6	192.168.6.1/24	v
LAN7	192.168.7.1/24	v	LAN8	192.168.8.1/24	v
DMZ PORT	192.168.17.1/24	v	IP Routed Subnet	192.168.0.1/24	v

**IPv4 Internet Access**

	Line / Mode	IP Address	MAC Address	Up Time
WAN1	ADSL / ---	Disconnected	00-1D-AA-F7-C0-F1	00:00:00
WAN2	Ethernet / DHCP Client	Disconnected	00-1D-AA-F7-C0-F2	00:00:00
WAN3	USB / ---	Disconnected	00-1D-AA-F7-C0-F3	00:00:00
WAN4	USB / ---	Disconnected	00-1D-AA-F7-C0-F4	00:00:00

**Interface**

DSL	Connected : Down Stream : 0Kbps / Up Stream : 0Kbps
WAN	Connected : 0, WAN1 WAN2 WAN3 WAN4
LAN	Connected : 0, Port1 Port2 Port3 Port4



**Note**

The home page will change slightly in accordance with the router you have.

If your router can be under an environment with high speed NAT, the configuration provide here can help you to deploy and use the router quickly. The first screen of **Quick Start Wizard** is entering login password. After typing the password, please click **Next**.

**Quick Start Wizard**

**Enter login password**

Please enter an alpha-numeric string as your **Password** (Max 23 characters).

Old Password	<input type="password" value="*****"/>
New Password	<input type="password" value="*****"/>
Confirm Password	<input type="password" value="*****"/>



On the next page as shown below, please select the WAN interface that you use. If DSL interface is used, please choose WAN1; if Ethernet interface is used, please choose WAN2; if 3G USB modem is used, please choose WAN3 or WAN4. Then click **Next** for next step. WAN1, WAN2, WAN3 and WAN4 will bring up different configuration page. Here, we take WAN1 (ADSL/VDSL2) as an example.

**Quick Start Wizard**

---

**WAN Interface**

WAN Interface:	WAN1
Display Name:	
Physical Mode:	ADSL / VDSL2
Physical Type:	Auto negotiation
VLAN Tag insertion (ADSL):	Disable
VLAN Tag insertion (VDSL2):	Disable

< Back    Next >    Finish    Cancel

Click **Next** to go to the following page. You have to select the appropriate Internet access type according to the information from your ISP. For example, you should select PPPoE mode if the ISP provides you PPPoE interface. In addition, the field of **For ADSL Only** will be available only when ADSL is detected. Then click **Next** for next step.

**Quick Start Wizard**

---

**Connect to Internet**

<b>WAN 1</b>	
Protocol	MPoA / Static or Dynamic IP
<b>For ADSL Only:</b>	
Encapsulation	1483 Bridged IP LLC
VPI	0    Auto detect
VCI	88
Fixed IP	<input checked="" type="radio"/> Yes <input type="radio"/> No(Dynamic IP)
IP Address	192.16.20.86
Subnet Mask	255.255.255.0
Default Gateway	192.16.20.1
Primary DNS	8.8.4.4
Second DNS	168.95.192.1

< Back    Next >    Finish    Cancel

## PPPoE/PPPoA

1. Choose WAN1 as WAN Interface and click the Next button; you will get the following page.

### Quick Start Wizard

---

#### Connect to Internet

<b>WAN 1</b>	
Protocol	PPPoE / PPPoA
<b>For ADSL Only:</b>	
Encapsulation	PPPoE LLC/SNAP
VPI	0 <span>Auto detect</span>
VCI	88
Fixed IP	<input checked="" type="radio"/> Yes <input type="radio"/> No(Dynamic IP)
IP Address	192.16.20.86
Subnet Mask	255.255.255.0
Default Gateway	192.16.20.1
Primary DNS	8.8.4.4
Second DNS	168.95.192.1

2. After finished the above settings, simply click Next.

### Quick Start Wizard

---

#### Set PPPoE / PPPoA

<b>WAN 1</b>	
Service Name (Optional)	CHTI
Username	77494727@hinet.net
Password	*****
Confirm Password	*****

3. Please manually enter the Username/Password provided by your ISP. Then click **Next** for viewing summary of such connection.

#### Quick Start Wizard

---

**Please confirm your settings:**

WAN Interface:	WAN1
Physical Mode:	ADSL / VDSL2
VPI:	0
VCI:	33
Protocol / Encapsulation:	PPPoE / LLC
Fixed IP:	No
Primary DNS:	8.8.8.8
Secondary DNS:	8.8.4.4

4. Click **Finish**. A page of **Quick Start Wizard Setup OK!!!** will appear. Then, the system status of this protocol will be shown.
5. Now, you can enjoy surfing on the Internet.

## MPoA / Static or Dynamic IP

1. Choose WAN1 as WAN Interface and click the Next button; you will get the following page.

Quick Start Wizard

---

**Connect to Internet**

**WAN 1**

Protocol: MPoA / Static or Dynamic IP

**For ADSL Only:**

Encapsulation: 1483 Bridged IP LLC

VPI: 0

VCI: 88

Fixed IP:  Yes  No(Dynamic IP)

IP Address: 192.16.20.86

Subnet Mask: 255.255.255.0

Default Gateway: 192.16.20.1

Primary DNS: 8.8.4.4

Second DNS: 168.95.192.1

2. Please type in the IP address/mask/gateway information originally provided by your ISP. Then click Next for viewing summary of such connection.

Quick Start Wizard

---

**Please confirm your settings:**

WAN Interface:	WAN1
Physical Mode:	ADSL / VDSL2
VPI:	0
VCI:	33
Protocol / Encapsulation:	1483 Route LLC
Fixed IP:	No
Primary DNS:	8.8.8.8
Secondary DNS:	8.8.4.4

3. Click Finish. A page of Quick Start Wizard Setup OK!!! will appear. Then, the system status of this protocol will be shown.
4. Now, you can enjoy surfing on the Internet.

## 6. Customer Service

If the router cannot work correctly after trying many efforts, please contact your dealer for further help right away. For any questions, please feel free to send e-mail to [support@draytek.com](mailto:support@draytek.com).